

# estebro®

Desde 1962



Catálogo | Catalogue

1/2021

Herrajes y Accesorios para Puertas

Ferragens e Acessorios para Portas

Gate Hardware and Accessories

Ferrures et Accessoires pour Portes et Portails





8

**Pernios y Bisagras**

Pernos e Drobradiças

Hinges

Paumelles et Charnières



11

**Herrajes para puertas correderas**

Ferragens para portas corrediças

Sliding doors hardware

Ferrures pour portes coulissantes



16

**Herrajes para puertas autoportantes**

Ferragens para portas autoportantes

Cantilever gate hardware

Ferrures pour portes autoportantes



18

**Herrajes para puertas correderas colgadas**

Ferragens para portas corrediças penduradas

Hanging sliding doors hardware

Ferrures pour portes coulissantes suspendues



26

**Herrajes para puertas correderas rústicas**

Ferragens para portas corrediças rusticas

Rustic sliding doors hardware

Ferrures pour portes coulissantes rustiques



28

**Herrajes para puertas elevables**

Ferragens para portas de elevar

Overhead doors hardware

Ferrures pour portes basculantes



29

**Herrajes para puertas de cancela**

Ferragens para portas de cancela

Swing gates fittings

Ferrures pour portails

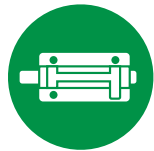

30

**Cerros y Pasadores**

Ferrolhos - Passadores

Bolts

Verrous

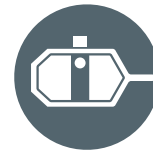

31

**Varios**

Varios

Other products

Produits divers



32

**Manillas y Tiradores Inox**

Manilhas e Puxadores Aço Inox

Stainless steel handles and Pull handles

Béquilles et Poignées en Acier Inox



33

**Herrajes de protección**

Ferragens de proteção

Protection hardware

Ferrures de protection



Compra online clientes  
[www.estebro.es](http://www.estebro.es)

**ES** Desde 1962 fabricando herrajes Fabricación especial y a medida

Desde 1962 en Estebro hemos apostado por la fabricación de calidad, la innovación, el desarrollo de nuevos productos, el buen servicio y trato a nuestros clientes.

La inversión en maquinaria de última generación, la alta preparación de nuestro equipo humano, la fabricación de nuestras propias matrices y utillajes, el control de producción, la calidad de nuestra fabricación y nuestro gran stock de producto terminado, nos permiten dar una rápida solución a los diferentes productos, tanto estándar como a medida, demandados a nivel mundial.

Somos fabricantes. Nuestro equipo de ingenieros y nuestra maquinaria de última generación nos permiten dar solución a los diferentes productos a medida que pueda necesitar.

Garantía de Calidad

Nuestro compromiso con la calidad y la satisfacción al cliente nos lleva a cumplir con la Norma ISO-9001, garante de un sistema de gestión de calidad eficaz.



**PO** Fabricando ferragens desde 1962 Fabricação especial e sob medida

Desde 1962 Estampaciones Ebro, apostamos pela fabricação de qualidade, a inovação, o desenvolvimento de novos produtos e sobre tudo o bom serviço e trato aos clientes.

A inversao em maquinarias de ultima geração, a alta preparação da nossa equipa humana, a fabricação própria das nossas matrizes e ferramentas, o control de produção e qualidade da nossa fabricação e nosso stock de produto acabado permitem-nos dar uma rápida solução aos diferentes produtos, tanto standard como a medida, demandados a nível mundial.

Somos fabricantes.A nossa equipe de engenheiros e a nossa maquinaria de última geração permitem-nos dar solução aos diferentes produtos sob medida que possa precisar.

Garantia de Qualidade

O nosso compromisso com a qualidade e a satisfação ao cliente levam-nos a cumprir com norma ISO-9001, garantidor de um sistema de gestao da qualidade eficaz.



## Hardware manufacturer since 1962 Tailor-made production

Since 1962 Estampaciones EBRO's has been manufacturing high quality fittings. Our main goals have always been high quality production, innovation, development of new products and specially a good service to our customers.

The investment in the latest machinery, the manufacture of our own moulds and tools, the production control and the quality control and our warehouse of finished products we give fast solutions to the different demanded products (standard and tailor-made products) all over the world.

We are manufacturers. Our engineering team and our latest generation machinery allow us to manufacture all sort of products tailored to our customer necessities.

## Quality Guarantee

Our commitment with quality and with the satisfaction of our customers leads us to fulfil with the Norm ISO-9001, guarantee of an effective quality system.

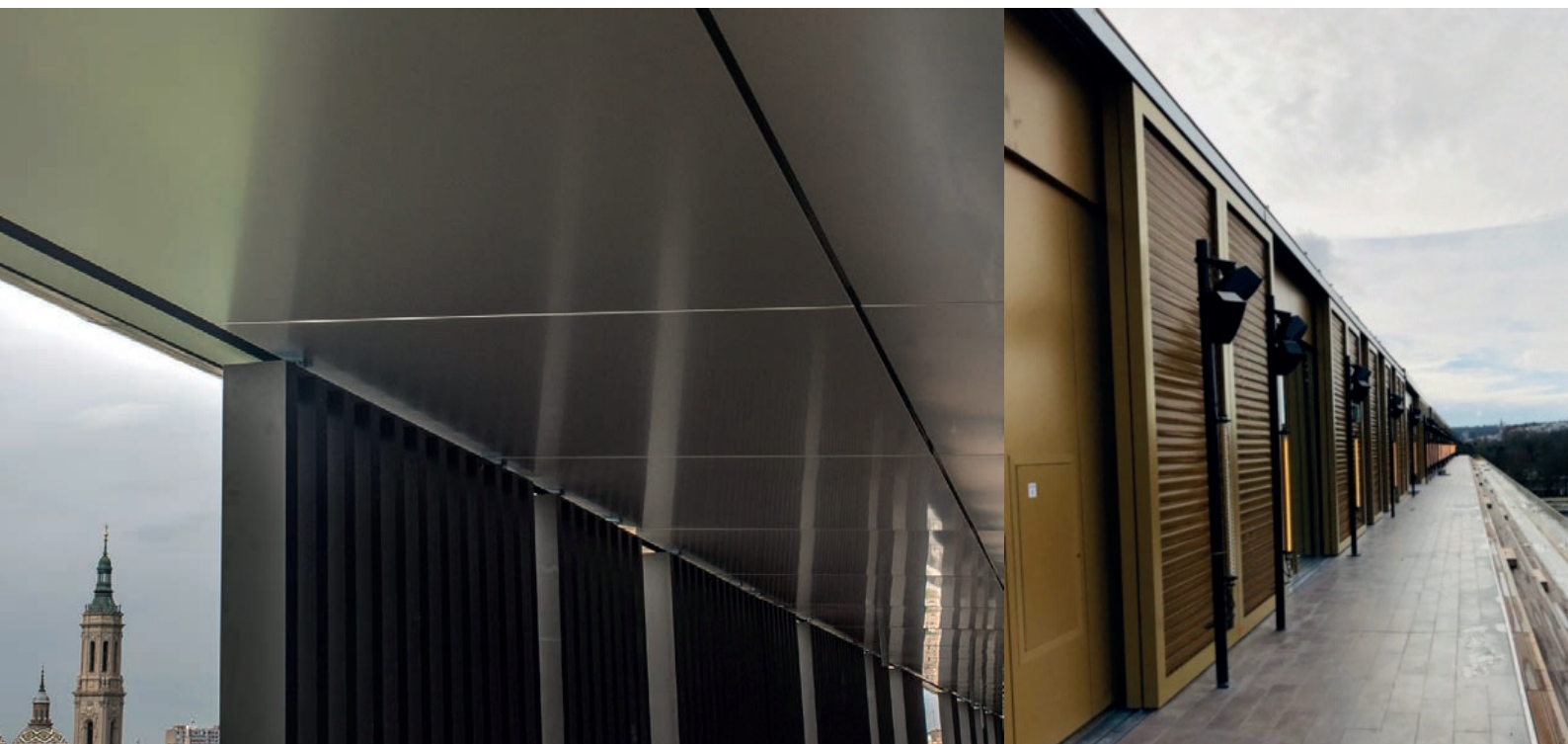

## Fabricant de ferrures depuis 1962 Fabrication spéciale et sur mesure

Depuis 1962 Estampaciones EBRO parie sur la fabrication de qualité, l'innovation et le développement de nouveaux produits, et surtout sur le bon service à ses clients.

L'investissement en machines de dernière génération, l'adéquate préparation de notre équipe humaine, la fabrication propre de nos matrices et outillages, le contrôle de la production et qualité de nos fabriqués, et notre gros stock de produit fini, nous permettent de donner une solution très rapide aux demandes à l'échelle mondiale, pas seulement de produits standards mais aussi sur mesure.

Nous sommes fabricants. Grâce à notre équipe d'ingénieurs et notre parc machines de dernière génération, nous pouvons trouver une solution aux exigences techniques de nos clients.

## Garantie de Qualité

Notre compromis de qualité et satisfaction client nous mène à l'accomplissement de la norme ISO-9001, garantie d'un système efficace de gestion de la qualité.





### Pernios y Bisagras

Pernos e Dobradiças

Hinges

Paumelles et Charnières

**A**  
CERO  
STEEL | ACIER

**I**  
NOX  
STAINLESS  
STEEL



### Herrajes para puertas correderas

Ferragens para portas corredeiras

Fittings for sliding doors

Ferrures pour portes coulissantes

**A**  
CERO  
STEEL | ACIER

**I**  
NOX  
STAINLESS  
STEEL

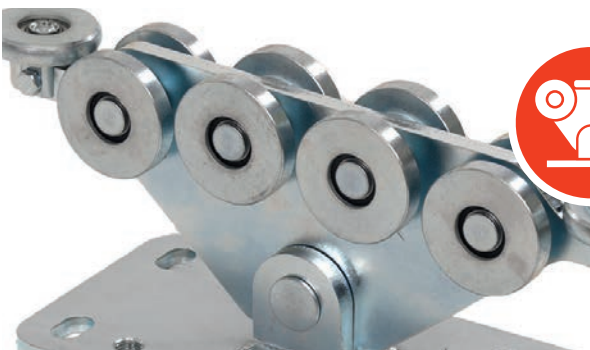

### Herrajes para puertas autoportantes

Ferragens para portas autoportantes

Cantilever gate hardware

Ferrures pour portes autoportantes



### Herrajes para puertas rústicas

Ferragens para portas rústicas

Fittings for rustic doors

Ferrures pour portes rustiques



### Herrajes para puertas correderas colgadas

Ferragens para portas corredeiras penduradas

Fittings for hanging sliding doors

Ferrures pour portes coulissantes suspendues

**A**  
CERO  
STEEL | ACIER

**I**  
NOX  
STAINLESS  
STEEL

**A**  
luminio  
ALUMINIUM  
ALUMINUM

**M**  
ADERA  
WOOD | BOIS



## Herrajes para puertas de cancela

Ferragens para portas de cancela  
Swing gates fittings  
Ferrures pour portails

**A**  
CERO  
STEEL | ACIER

**I**  
NOX  
STAINLESS  
STEEL

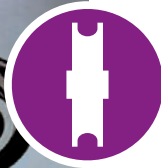

## Herrajes para puertas basculantes

Ferragens para portas de elevar  
Fittings for overhead doors  
Ferrures pour portes basculantes

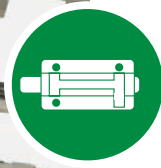

## Cerrojos y Pasadores

Ferrolhos - Passadores  
Bolts  
Verrous

**A**  
CERO  
STEEL | ACIER

**I**  
NOX  
PULIDO  
POLI | POLISH  
SATINADO  
SATINÉ | SATIN  
STAINLESS  
STEEL

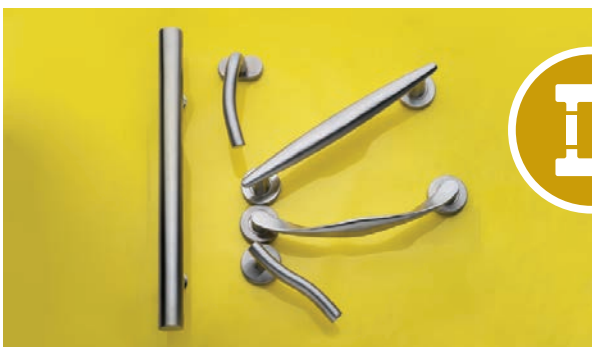

## Manillas y Tiradores Inox

Manilhas e Puxadores Inox  
Stainless steel handles and Pull handles  
Béquilles et Poignées Inox

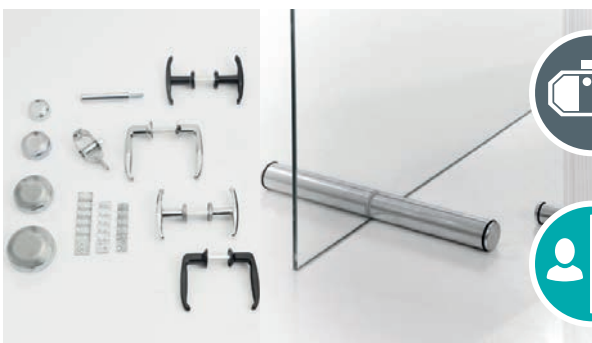

## Varios y Herrajes de protección

Varios e Ferragens de proteção  
Other products and Protection hardware  
Produits divers et Ferrures de protection

**A**  
CERO  
STEEL | ACIER

**I**  
NOX  
STAINLESS  
STEEL



## Pernios Torneados



**Con arandela de latón**  
 Com anilha de latão | With brass washer |  
 Avec bague laiton

Cod.	Medidas-Dimensions	
31	8x50	100
1	10x60	60
4	12x70	45
5	12x80	45
6	14x80	28
7	14x100	24
8	16x80	24
9	16x100	35
32	16x100 Engrasador	35
10	16x120	30
33	16x120 Engrasador	30
11	18x100	30
12	18x110	24
13	18x120	24
14	20x100	24
15	20x120	20
16	22x120	16
17	25x120	12
18	25x150	12
19	30x150	8
20	30x200	12
21	35x150	6
22	35x200	12
<b>INOX - Stainless steel</b> AISI 303		
86	8x50	20
79	10x60	20
84	12x70	20
80	14x80	14
81	16x100	15
82	18x110	12
83	20x120	10
85	25x150	6
286	30x150	4
<b>INOX - Stainless steel</b> AISI 316		
280	12x70	20
281	16x100	15
282	20x120	10
283	25x150	6
<b>INOX PULIDO   Polido   Polish   Poli</b> AISI 303		
81P	16x100	15
83P	20x120	10
85P	25x150	6



**Con rodamiento axial**  
 Com rolamento axial | With axial bearing |  
 Avec roulement à billes

Cod.	Medidas-Dimensions	
272	14x80	28
273	16x100	35
30	20x120	20
274	22x120	16
27	25x120	12
28	25x150	12
29	30x150	8
291	30x150 Pistas	8
496	35x150 Pistas	6
495	35x200 Pistas	12
490	40x160 Pistas	6
<b>INOX - Stainless steel</b> AISI 303		
8012	14x80	14
8111	16x100	15
831	20x120	10
851	25x150	6
<b>INOX - Stainless steel</b> AISI 316		
81110	16x100	15
284	20x120	10
285	25x150	6
<b>INOX PULIDO   Polido   Polish   Poli</b> AISI 303		
8111P	16x100	15
831P	20x120	10
851P	25x150	6



**Regulable**  
 Regulável | Regulating | Réglable

Cod.	Medidas-Dimensions	
613	20x120 M.10	20
614	25x150 M.10	12
615	30x150 M.12	8
<b>INOX - Stainless steel</b> AISI 303		
624	20x100 M.10	12
625	25x150 M.10	6

**Cincada | Zincada | Zinc plated | Zinguée**

Cod.	Medidas-Dimensions	
195RZ	80 mm	20
196RZ	100 mm	12
197RZ	150 mm	10

## Bisagras Libro



Cod.	Medidas-Dimensions	
195R	80 mm	20
196R	100 mm	12
197R	150 mm	10
<b>INOX - Stainless steel</b> AISI 304		
1950	80 mm	20
1960	100 mm	12
1970	150 mm	10

## Dobradiças Livro Butt Hinges Charnières Livre



**Cincada | Zincada | Zinc plated | Zinguée**

Cod.	Medidas-Dimensions	
195RZ	80 mm	20
196RZ	100 mm	12
197RZ	150 mm	10

## Pernos Torneados Round Profile Hinges Paumelles Profil Rond



**Con bola**  
 Com bola | With ball | Avec bille

Cod.	Medidas-Dimensions	
23	20x120	20
24	25x120	12
25	25x150	12
26	30x150	8
494	30x200	12
489	35x150	6
493	35x200	12
492	40x160	6
491	40x200	6



**Deslizante**  
 Deslizante | Sliding | Glissante

Cod.	Medidas-Dimensions	
40	20x120	20



**Con muelle**  
 Com mola | With spring | Avec ressort

Cod.	Medidas-Dimensions	
34IZ	25x120 lzd Left	12
34D	25x120 Dch Right Droite	12
<b>INOX - Stainless steel</b> AISI 316		
35IZ	25x120 lzd Left	2
35D	25x120 Dch Right Droite	2



**Engrasador**  
 Engrasador | Greaser | Graisseur

- ES** Pernios Ø16 con o sin engrasador. De Ø18 en adelante todos con engrasador.
- PO** Pernos Ø16 com u sem engraxador. A partir de Ø18, todos com engraxador.
- EN** Hinges Ø16 with or without greaser. From Ø18 on, all with greaser.
- FR** Paumelles Ø16 avec / sans graisseur. À partir de Ø18, graisseur toujours inclus.





## Pernios Perfil Gota

## Pernos Perfil Gota Drop Profile Hinges Paumelles Profil Goutte



**Con arandela de latón**  
Com anilha de latão | With brass washer |  
Avec bague laiton

Cod.	Medidas-Dimensions	
42	10x45	60
43	10x60	60
44	14x80	28
45	14x100	24
46	16x100	35
47	16x120	30
48	20x120	18
513	20x140	15
49	20x150	15
514	20x160	12
59	23x150	12
71	23x180	10
<b>INOX - Stainless steel</b> <b>AISI 304</b>		
708	10x60	20
<b>INOX - Stainless steel</b> <b>AISI 316</b>		
709	14x80	15
710	16x80	15
711	16x100	15
712	20x120	10
713	20x150	8
714	23x150	6
715	23x180	5
<b>INOX PULIDO   Polido   Polish   Poli</b> <b>AISI 303</b>		
711P	16x100	15
712P	20x120	10
714P	23x150	6



**Con arandela inox**  
Com anilha inox | With stainless steel washer |  
Avec bague inox

Cod.	Medidas-Dimensions	
<b>INOX - Stainless steel</b> <b>AISI 316</b>		
628	16x80	15
629	16x100	15
728	20x120	10
729	20x150	8



**Con rodamiento axial**  
Com rolamento axial | With axial bearing |  
Avec roulement à billes

Cod.	Medidas-Dimensions	
53	14x80	28
54	14x100	24
55	16x100	35
56	16x120	25
57	20x120	18
581	20x140	15
58	20x150	15
72	23x150	12
73	23x180	8
<b>INOX - Stainless steel</b> <b>AISI 316</b>		
720	14x80	15
721	16x80	15
722	16x100	15
723	20x120	10
724	20x150	8
725	23x150	6
726	23x180	5
<b>INOX PULIDO   Polido   Polish   Poli</b> <b>AISI 316</b>		
722P	16x100	15
723P	20x120	10
725P	23x150	6



### Engrasador Engrazador | Greaser | Graisseur



Pernios Ø16 con o sin engrasador.  
De Ø18 en adelante todos con engrasador.



Pernos Ø16 com u sem engraxador.  
A partir de Ø18, todos com engraxador.



Hinges Ø16 with or without greaser.  
From Ø18 on, all with greaser.



Paumelles Ø16 avec / sans graisseur.  
À partir de Ø18, graisseur toujours inclus.

## Pernios Perfil Gota Regulares

## Pernos Perfil Gota Ajustáveis Regulating Drop Profile Hinges Paumelles Profil Goutte Réglables



INOX - SS

**Regulable**  
Regulável | Regulating | Réglable

Cod.	Medidas-Dimensions	
617	14x80 M.6	21
618	16x100 M.8	15
619	20x120 M.10	18
620	23x150 M.10	12
<b>INOX - Stainless steel</b> <b>AISI 316</b>		
626	20x120 M.10	10
627	23x150 M.10	6



**Regulable 3D**  
Regulável 3D | Regulating 3D | Réglable 3D

Cod.	Medidas-Dimensions	
287	16x120	2
<b>INOX - Stainless steel</b> <b>AISI 316</b>		
288	16x120	2



**Pernio gota con muelle**  
Perno gota com mola | Drop profile hinge with spring |  
Paumelle goutte avec ressort

Cod.	Medidas-Dimensions	
276	22x250	8



### Descripción Regulable 3D Descrição Regulável 3D | Description Regulating 3D | Description Réglable 3D



Pernio Gota que permite regular la altura y el desplazamiento de la puerta, mediante llaves Allen. Una vez conseguida la posición deseada, se fija mediante prisioneros laterales.



Dobradora gota que permite regular a altura e o movimento da porta, utilizando uma chave Allen. Uma vez alcançada a posição desejada, é fixada por prisioneiros laterais.



It's a drop profile hinge permitting to regulate the height and allows the movement of the door through Allen wrenches. Once the desired sitting is reached, the hinge is fixed through side fastening screws.



C'est une paumelle profil goutte qui permet d'ajuster la hauteur et de faire bouger la porte, à l'aide de clefs Allen. Une fois que la position souhaitée est



## Pernios de Pala

## Dobradiças em forma de "Pa" Flag Hinges Paumelles Roulées

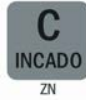

### Con rodamiento axial

Com rolamento axial

With axial bearing

Avec roulement à billes



Cod.	Cod.	Medidas-Dimensions	R
Eje Cincado	Eixo Zincado	Zinc plated Axle	Axe Zingué

60	60R	10x60x2	100 40
61	61R	12x80x2	80 30
62	62R	14x80x3	50 20
63	63R	16x100x3	50 24
64	64R	18x110x4	40 16
65	65R	20x120x5	30 12
66	66R	25x120x5	24 10
67	67R	30x150x6	24 8
68	68R	12x80x2 Corta Short Courte	100 40
69	69R	14x80x3 Corta Short Courte	90 24
70	70R	16x100x3 Corta Short Courte	60 30

Cincado Completo	Zingué	Zinc plated	Zincado
------------------	--------	-------------	---------

60Z	10x60x2 ZN	100
61Z	12x80x2 ZN	80
62Z	14x80x3 ZN	50
63Z	16x100x3 ZN	50
64Z	18x110x4 ZN	40
65Z	20x120x5 ZN	30
66Z	25x120x5 ZN	24
67Z	30x150x6 ZN	24
68Z	12x80x2 Corta Short Courte ZN	100
69Z	14x80x3 Corta Short Courte ZN	90
70Z	16x100x3 Corta Short Courte ZN	60



### Pernio pala larga

Dobradiça em forma de "pá" longa | Long flag hinge | Paumelle roulée longue

Cod.	Medidas-Dimensions	R	
Eje Cincado	Eixo Zincado	Zinc plated Axle	Axe Zingué
68072	14x80 Larga	20	
68074	16x100 Larga	20	

### INOX AISI 304L | Dobradiça de "pá" inox | Stainless steel flag hinge | Charnière roulée inox

Cod.	Medidas-Dimensions	AISI 304L
602	12x80x2 Izq Left Gauche	18
603	12x80x2 Dch Right Droite	18
604	18x100x3 Izq Left Gauche	12
605	18x100x3 Dch Right Droite	12
606	20x140x3 Izq Left Gauche	6
607	20x140x3 Dch Right Droite	6

INOX PULIDO   Polido   Polish   Poli	AISI 304
--------------------------------------	----------

602P	12x80x2 Izq Left Gauche	18
603P	12x80x2 Dch Right Droite	18
604P	18x100x3 Izq Left Gauche	12
605P	18x100x3 Dch Right Droite	12
606P	20x140x3 Izq Left Gauche	6
607P	20x140x3 Dch Right Droite	6



### Pernio pala 3 cuerpos cincado

Dobradiça 3 corpos zincado  
3 sections flag hinge zinc plated  
Paumelle roulée 3 corps zingué

Cod.	Medidas-Dimensions	R	
Cincado Completo	Zingué	Zinc plated	Zincado
68080	185x180x6	8	



## Pernios de Tres Cuerpos

## Dobradiças Três Corpos Three Section Hinges Paumelles Trois Corps



Cod.	Medidas-Dimensions	R
50	16x100	30
51	20x120	20
52	25x150	12
390	30x175	12
391	35x175	6

### INOX AISI 303 - Stainless steel

Cod.	Medidas-Dimensions	AISI 303
510	16x100	15
511	20x120	10
512	25x150	6

## Bisagras Inoxidables

## Dobradiças Inox Stainless Steel Hinges Charnières Inox

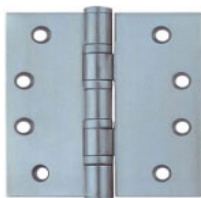

### Atornillar con rodamiento INOX AISI 304

Parafusar com rolamento | To screw with bearing | A visser avec roulement billes

Cod.	Medidas-Dimensions	R
INOX - Stainless steel	AISI 304	
520SS	100x75x2,5	2
525SS	100x100x2,5	2

## Herrajes Puertas Correderas

## Ferragens Portas Corrediças Sliding Doors Fittings Ferrures Portes Coulissantes



### Carril EMPOTRAR mariposa "U" 20 mm

Trilho embutir | Track to fit | Rail à sceller

Cod.	Medidas-Dimensions	±1%
533	U-20 Galvanizado	3 m
INOX - Stainless steel		AISI 304L
530	U-20	3 m

ES: Empalme gratis cada 2 barras de 3 m.

PO: Conexão grátis cada 2 barras de 3 m.

EN: Free joint for rails every 2 rails of 3 m.

FR: Joints gratuits pour chaque 2 barres de 3 m.



Cod. 522



### Carril EMPOTRAR mariposa "U" 20 SIN agujero

Trilho embutir | Track to fit | Rail à sceller

Cod.	Medidas-Dimensions	±1%
5330	U-20 Galvanizado	3 m

ES: Empalme gratis cada 2 barras de 3 m.

PO: Conexão grátis cada 2 barras de 3 m.

EN: Free joint for rails every 2 rails of 3 m.

FR: Joints gratuits pour chaque 2 barres de 3 m.



Cod. 522



### Carril EMPOTRAR "U"

Trilho embutir | Track to fit | Rail à sceller

Cod.	Medidas-Dimensions	±1%
536	U-20 Galvanizado	3 m
540	U-16 Galvanizado	3 m
INOX - Stainless steel		AISI 304L
5404	U-16	3 m

ES: Empalme gratis cada 2 barras de 3 m.

PO: Conexão grátis cada 2 barras de 3 m.

EN: Free joint for rails every 2 rails of 3 m.

FR: Joints gratuits pour chaque 2 barres de 3 m.



Cod. 519 U-20  
Cod. 520 U-16



### Empalme carril EMPOTRAR

Conexão trilho embutir | Joint track to fit

Joint rail à sceller

Cod.	Medidas-Dimensions	±1%
522	Para carril 533 y 5330	1
519	Para carril 536	1
520	Para carril 540	1
INOX - Stainless steel		AISI 303
524	Para carril 530	1
523	Para carril 5404	1



### Carril ATORNILLAR "U"

Trilho parafusar | Track to screw | Rail à visser

Cod.	Medidas-Dimensions	±1%
535	U-20 Galvanizado	3 m
539	U-16 Galvanizado	3 m
INOX - Stainless steel		AISI 304L
531	U-20	3 m
5391	U-16	3 m

\* Consultar raíl sin punzonar



### Carril ATORNILLAR "V" 20 mm

Trilho parafusar | Track to screw | Rail à visser

Cod.	Medidas-Dimensions	±1%
537	V-20 Galvanizado	3 m
INOX - Stainless steel		AISI 304L
532	V-20	3 m

\* Consultar raíl sin punzonar

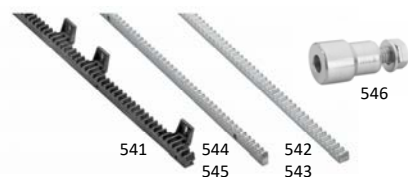

### Cremallera módulo 4

Cremalheira mod.4 | Rack mod.4 |

Crémaillère mod.4

Cod.	Medidas-Dimensions	±1%
541 *	20x28 NYLON	1 m
544 *	Atornillar 12x30	1 m
545 *	Atornillar 12x30	2 m
542	Soldar 20x20	1 m
543	Soldar 20x20	2 m
546	Tornillo 30x12	1

ES: Tornillos gratis. 1 m = 3 un, 2 m = 4 un

PO: Parafusos gratis. 1 m = 3 un, 2 m = 4 un

EN: Free screws. 1 m = 3 screws, 2 m = 4 screws

FR: Vis gratuites. 1 m - 3 vis, 2 m - 4 vis



### Polea guía nylon

Polia guía de nylon | Nylon roller | Olive de guidage

Cod.	Medidas-Dimensions	±1%
700	25x35 M.12	24
133	30x30 M.16	36
132	35x35 M.16	25
134	40x40 M.16	20
1342	40x40 M.16 Largo Long	20
701	40x60 M.16	16
INOX - Stainless steel		AISI 303
1332	30x30 M.16	12
1321	35x35 M.16	10
1341	40x40 M.16	8



### Polea guía nylon largo

Polia guía de nylon longa | Long nylon roller |

Olive de guidage longue

Cod.	Medidas-Dimensions	±1%
1901	35x150 M.16	6
1902	35x250 M.16	6



### Caja de poleas guía simple regulable

Caixa regulável | Adjustable plate | Plaque guide

Cod.	Regulable	±1%
161	6-94 Ø30	12
1614	11-89 Ø35	12
INOX - Stainless steel		AISI 303-304
306	6-94 Ø30	4



### Caja de poleas guía regulable

Caixa regulável | Adjustable plate | Plaque guide

Cod.	Regulable	±1%
167	30-65 Ø30	6
1675	25-60 Ø35	6
171	58-92 Ø40	6
INOX - Stainless steel		AISI 303-304
358	30-65 Ø30	4
359	58-92 Ø40	1



### Caja de poleas guía regulable a pared

Caixa regulável | Adjustable plate | Plaque guide

Cod.	Regulable	±1%
1673	20-76 Ø40	4
INOX - Stainless steel		AISI 303-304
16730	20-76 Ø40	4



## Herrajes Puertas Correderas

## Ferragens Portas Corrediças Sliding Doors Fittings Ferrures Portes Coulissantes



**Tapa de seguridad para poleas guía**  
Tampa seguraça poleas guia  
Security cover nylon rollers  
Couverture de sécurité pour plaques guide

Cod.	Para-For-Pour	
1674	35x35	10
17100	40x40	10



**Polea guía en hierro**  
Polia guia ferro | Steel guide sheave |  
Guide acier

Cod.	Medidas-Dimensions	
130	42 mm U-50	12
131	52 mm U-60	12
1311	72 mm U-80	1



**Freno hidraulico ajustable cremallera M4**  
Freio hidráulico | Hydraulic brake for rack |  
Frein hydraulique pour crémaillère

Cod.	Medidas-Dimensions	
470050	Modulo 4	1



**Polea pivotante**  
Polia pivot | Pivot wheel | Roue pivotante

Cod.	Medidas-Dimensions	
147	120x16	2



**Polea canal "U" 20 mm**  
Polia canal U-20 | U-20 wheel | Galet U-20

Cod.	Medidas-Dimensions	
447	70x20	20
124	80x20	16
107	90x20	8
123	100x20	8
108	120x20	6
109	150x20	4
355	160x20	4
117	180x20	4
110	200x20	4
INOX - Stainless steel		AISI 303
395	80x20	6
396	100x20	4
397	120x20	2



**Polea canal ángulo "V"**  
Polia Canal V-20 | V-20 wheel | Galet V-20

Cod.	Medidas-Dimensions	
446	70 V	20
379	80 V	16
125	90 V	8
128	100 V	8
126	120 V	6
127	150 V	4
3562	200 V	4
INOX - Stainless steel		AISI 303
144	80 V	6
398	100 V	4
399	120 V	2



**POLEAS Peso Máximo Soportado**  
Maximum Loading Capacity per WHEEL  
Poids Maximum Supporté par GALET



Ø > 80  
mm

max.  
655  
kg



**Polea canal "U" 20 mm con caja**  
Polia com caixa | Wheel with box | Galet en applique

Cod.	Medidas-Dimensions	
300	80x20	12
301	90x20	9
302	100x20	8
303	120x20	6
304	150x20	2
305	200x20	4
INOX - Stainless steel		AISI 303-304
672	80x20	6
673	100x20	4
674	120x20	2



**Polea canal "V" 20 mm con caja**  
Polia com caixa | Wheel with box | Galet en applique

Cod.	Medidas-Dimensions	
445	80 V	12
307	90 V	9
308	100 V	8
309	120 V	6
310	150 V	2
INOX - Stainless steel		AISI 303-304
675	80 V	6
676	100 V	4
677	120 V	2



**Polea canal "U" 20 mm para encastrar**  
Polia de encastrar | Wheel to fit | Galet à encastrer

Cod.	Medidas-Dimensions	
159	80x20	10
168	90x20	10
169	100x20	8
170	120x20	4
251	150x20	2
INOX - Stainless steel		AISI 303-304
678	80x20	6
679	100x20	4
680	120x20	2

## Herrajes Puertas Correderas

## Ferragens Portas Corrediças Sliding Doors Fittings Ferrures Portes Coulissantes



Inox-SS

### Polea canal "V" 20 mm para encastrar

Polia de encastrar | Wheel to fit | Galet à encastrer

Cod.	Medidas-Dimensions	
152	80 V	10
172	90 V	10
173	100 V	8
174	120 V	4
263	150 V	2
INOX - Stainless steel		AISI 303-304
681	80 V	6
682	100 V	4
683	120 V	2



### Polea canal "U" 20 mm con soporte

Polia com suporte | Wheel to weld | Galet à souder

Cod.	Medidas-Dimensions	
419	80x20	12
586	80x20 Perfil 60	12
439	90x20	12
440	100x20	10
441	120x20	6
256	150x20	2
INOX - Stainless steel		AISI 303-304
684	80x20	4
685	100x20	4
686	120x20	2



### Polea canal "V" 20 mm con soporte

Polia com suporte | Wheel to weld | Galet à souder

Cod.	Medidas-Dimensions	
420	80 V	12
587	80 V Perfil 60	12
442	90 V	12
443	100 V	10
444	120 V	6
265	150 V	2
INOX - Stainless steel		AISI 303-304
687	80 V	4
688	100 V	4
689	120 V	2



### Polea canal "U" 16 mm

Polia canal U-16 | U-16 wheel | Galet gorge U-16

Cod.	Medidas-Dimensions	
146	80x16	8
425	90x16	8
426	100x16	8
427	120x16	6
428	150x16	4



### Polea canal "U" 16 mm con caja

Polia com caixa | Wheel with box | Galet en applique

Cod.	Medidas-Dimensions	
421	80x16	12
429	90x16	9
430	100x16	8
431	120x16	6
432	150x16	2



### Polea canal "U" 16 mm para encastrar

Polia de encastrar | Wheel to fit | Galet à encastrer

Cod.	Medidas-Dimensions	
422	80x16	10
433	90x16	10
434	100x16	8
435	120x16	4
266	150x16	2



### Polea canal "U" 16 mm con soporte

Polia U-16 con soporte | Wheel to weld U-16 | Galet à souder U-16

Cod.	Medidas-Dimensions	
423	80x16	12
436	90x16	12
437	100x16	10
438	120x16	6
267	150x16	2



### Polea NYLON canal "U" 20 mm

Polia nylon U-20 | U-20 nylon wheel | Galet nylon U-20

Cod.	Medidas-Dimensions	
369	80x20	16
370	90x20	8
371	100x20	8
372	120x20	6
373	150x20	4
3811	180x20	4
374	200x20	4
INOX - Stainless steel		AISI 303
730	80x20	6
731	90x20	4
732	100x20	4
733	120x20	2
734	150x20	2
735	200x20	2



### Polea NYLON canal "V" 20 mm

Polia nylon V-20 | V-20 nylon wheel | Galet nylon V-20

Cod.	Medidas-Dimensions	
380	80 V	16
375	90 V	8
376	100 V	8
377	120 V	6
378	150 V	4
INOX - Stainless steel		AISI 303
736	80 V	4
737	90 V	4
738	100 V	4
739	120 V	2
740	150 V	2



Opciones de suministros de poleas  
Opções de fornecimento de polias  
Wheels' supply options  
Fourniture galets



Casquillos o tornillo o eje.



Casquilhos o parafuso o eixo.



With reducing sleeves or axle or screw.



Avec bagues de réduction ou axe ou vis.



## Herrajes Puertas Correderas

Ferragens Portas Corrediças  
Sliding Doors Fittings  
Ferrures Portes Coulissantes



**Polea NYLON canal "U" 20 mm con caja**  
Polia com caixa | Wheel with box | Galet en applique

Cod.	Medidas-Dimensions	
312	80x20	12
313	90x20	9
314	100x20	8
315	120x20	6
316	150x20	2
317	200x20	4
INOX - Stainless steel		AISI 303-304
741	80x20	6
743	100x20	4
744	120x20	2

**Polea NYLON canal "V" 20 mm con caja**  
Polia com caixa | Wheel with box | Galet en applique

Cod.	Medidas-Dimensions	
311	80 V	12
318	90 V	9
319	100 V	8
320	120 V	6
321	150 V	2
INOX - Stainless steel		AISI 303-304
747	80 V	6
749	100 V	4
750	120 V	2

**Polea NYLON canal "U" 20 mm encastrar**  
Polia de encastrar | Wheel to fit | Galet à encastrer

Cod.	Medidas-Dimensions	
218	80x20	10
212	90x20	10
213	100x20	8
214	120x20	4
INOX - Stainless steel		AISI 303-304
752	80x20	6
753	90x20	6
754	100x20	4
755	120x20	2



**Polea NYLON canal "V" 20 mm encastrar**  
Polia de encastrar | Wheel to fit | Galet à encastrer

Cod.	Medidas-Dimensions	
219	80 V	10
215	90 V	10
216	100 V	8
217	120 V	4
INOX - Stainless steel		AISI 303-304
756	80 V	6
757	90 V	6
758	100 V	4
759	120 V	2

**Polea NYLON canal "U" 20 mm soporte**  
Polia com suporte | Wheel to weld | Galet à souder

Cod.	Medidas-Dimensions	
354	80x20	12
382	90x20	12
383	100x20	10
384	120x20	6
INOX - Stainless steel		AISI 303-304
760	80x20	4
761	90x20	6
762	100x20	4
763	120x20	2

**Polea NYLON canal "V" 20 mm soporte**  
Polia com suporte | Wheel to weld | Galet à souder

Cod.	Medidas-Dimensions	
353	80 V	12
385	90 V	12
386	100 V	10
387	120 V	6
INOX - Stainless steel		AISI 303-304
764	80 V	4
765	90 V	6
766	100 V	4
767	120 V	2

## Herrajes Correderas Pesadas

Portas Corrediças Pesadas  
Heavy Duty Sliding Doors  
Portes Coulissantes Lourdes



max.  
**1310**  
kg

**Polea canal 20 mm doble rodamiento**  
Polia dois rolamentos | Double bearing wheel |  
Galet double roulements

Cod.	Medidas-Dimensions	
1081	120x20U	6
1092	150x20U	4
356	200x20U	4
120	250x20U	3
121	300x20U	1
122	320x20U	1
1091	150x20V	4
3563	200x20V	4
87902	200x20 Cuadrada	4



max.  
**1200**  
kg

**Tandem Doble 120 mm**  
Tandem duplo 120 mm | Twin wheels 120 mm |  
Tandem Double 120 mm

Cod.	Medidas-Dimensions	
871	120x20U	2
872	120x20V	2
873	120x20 Cuadrada	2
874	120x16U	2



max.  
**2000**  
kg

**Tandem Doble 200 mm**  
Tandem duplo 200 mm | Twin wheels 200 mm |  
Tandem Double 200 mm

Cod.	Medidas-Dimensions	
877	200x20U	1
878	200x20V	1
879	200x20 Cuadrada	1

## Herrajes Puertas Correderas

## Ferragens Portas Corrediças Sliding Doors Fittings Ferrures Portes Coulissantes



### Cerradura de gancho 60 mm

Fechadura gancho | Hook lock | Serrure à crochet

Cod.		
325	Cilindro 55 mm latón centrado	1
3250	S/cilindro No cylinder S/cylindre	1



### Cerradura de gancho 30 mm

Fechadura gancho | Hook lock | Serrure à crochet

Cod.		
424	Cilindro 55 mm latón centrado	1
4240	S/cilindro No cylinder S/cylindre	1



### Caja para cerraduras

Caixa fechadura | Cover box | Couverture serrure

Cod.	Perfil-Profile-Profil	
326	40 mm	10
327	50 mm	10

\* Para Cods. 325 y 3250

### Tirador

Puxador | Puller | Poignée à encastrer

Cod.	Medidas-Dimensions	
576	175x76 Mediano	10
577	200x90 Grande	10



### Topo puerta corredera

Topo | Stopper | Arrêt

Cod.	Medidas-Dimensions	
5792	50x85	10
5802	70x130	12



### Topo puerta corredera atornillar

Topo parafusar | Stopper to screw | Arrêt à visser

Cod.	Medidas-Dimensions	
5803	70x130	2



## Poleas 60 mm Anti-atrapamiento y Anti-descarrilamiento

Compatibles con:



Cod. 539

Cod. 5391 INOX



Cod. 540

Cod. 5404 INOX

Para puertas de:



Características

- ✓ Poleas en acero inoxidable y acero cincado.
- ✓ Chapa de aluminio en bruto o lacada.
- ✓ Mayor resistencia a la corrosión: tornillería con tratamiento anti-corrosión (Géomet®) para una buena compatibilidad con el aluminio.
- ✓ Peso máximo soportado por unidad: 300 kg.
- ✓ Cincado de la polea grado 3.



### Polea caja aluminio 60x16 mm

Caixa alumínio | Aluminium box | Support en alu

Cod.		
36016	Aluminio Aluminium	2
36016/1	Blanco Branco White Blanc	2
36016/2	Negro Black Noir	2
INOX - Stainless steel		AISI 303
36016PI	Aluminio Aluminium	2
36016/1PI	Blanco Branco White Blanc	2
36016/2PI	Negro Black Noir	2



### Polea semi-encastar caja alu. 60x16 mm

Caixa alumínio | Aluminium box | Support en alu

Cod.		
26016	Aluminio Aluminium	2
26016/1	Blanco Branco White Blanc	2
26016/2	Negro Black Noir	2
INOX - Stainless steel		AISI 303
26016PI	Aluminio Aluminium	2
26016/1PI	Blanco Branco White Blanc	2
26016/2PI	Negro Black Noir	2



### Polea encastrar caja alu. 60x16 mm

Caixa alumínio | Aluminium box | Support en alu

Cod.		
16016	Aluminio Aluminium	2
16016/1	Blanco Branco White Blanc	2
16016/2	Negro Black Noir	2
INOX - Stainless steel		AISI 303
16016PI	Aluminio Aluminium	2
16016/1PI	Blanco Branco White Blanc	2
16016/2PI	Negro Black Noir	2

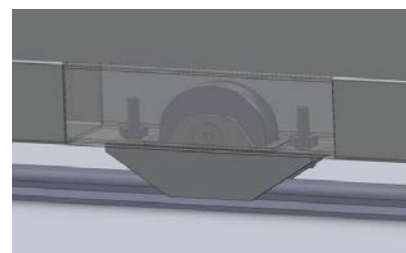
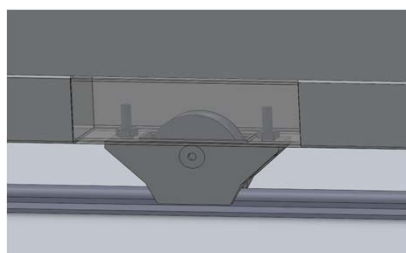
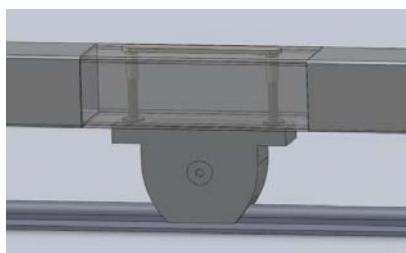



## Herrajes Puertas Autoportantes

## Ferragens Portas Autoportantes Cantilever Gate Hardware Ferrures pour Portes Autoportantes



### Carro autoportante axial simple

Carro Auto Portante Axial simple | Simple hanger for cantilever doors | Monture simple avec roulement à billes pour portes autoportantes

Cod.	Medidas-Dimensions	
861	Simple	2



### Carro autoportante axial doble

Carro Auto Portante axial duplo | Double hanger for cantilever doors | Monture double avec roulement à billes pour portes autoportantes

Cod.	Medidas-Dimensions	
862	Doble	1



### Rail autoportante U-70

Calha para Auto portante U-70 | Cantilever track U-70 | Rail pour portes autoportantes U-70

Cod.		
470		3 m



### Caja de poleas guía simple regulable

Caixa regulável | Adjustable plate | Plaque guide

Cod.	Regulable	
161	6-94 Ø30	12
1614	11-89 Ø35	12



### Caja de poleas guía regulable

Caixa regulável | Adjustable plate | Plaque guide

Cod.	Regulable	
167	30-65 Ø30	6
1675	25-60 Ø35	6
171	58-92 Ø40	6



### Caja de poleas guía regulable a pared

Caixa regulável | Adjustable plate | Plaque guide

Cod.	Regulable	
1673	20-76 Ø40	4



### Tapa de seguridad para poleas guía

Tampa seguraçã polias guia  
Security cover nylon rollers

Couverture de sécurité pour plaques guide

Cod.	Para-For-Pour	
1674	35x35	10
17100	40x40	10



### Tope encuentro

Topo de encontro | End stop | Arrêt

Cod.		
863		2

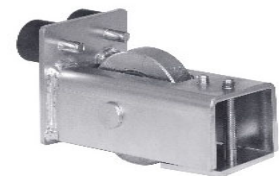

### Rueda encuentro

Roda de encontro | End wheel support | Galet de guidage

Cod.		
8631		2



### Soporte tope encuentro

Supporte topo de encontro | End stopper support | Support d'arrêt

Cod.		
8630		2



Kit=4 unid

### Kit Varilla recta fijación

Varão de fixação | Fastening pin | Tige de fixation

Cod.	Kit	
8602	Kit = 4 unids	1 Kit



Kit=4 unid

### Kit Varilla curva fijación

Varão de fixação curva | Curved fastening pin | Tige de fixation courbée

Cod.	Kit	
8622	Kit = 4 unids	1 Kit

\* Para | for | pour | Cods. 8610C y 8620C

\* Para | for | pour | Cods. 8610C y 8620C



### Chapa regulación

Chapa de regulação | Regulation plate | Plaque de régulation

Cod.	Medidas-Dimensions	
8610C	Simple	2
8620C	Doble	2



5792

5802

### Tope puerta corredera

Topo | Stopper | Arrêt

Cod.	Medidas-Dimensions	
5792	50x85	10
5802	70x130	12



### Tope puerta corredera atornillar

Topo parafusar | Stopper to screw | Arrêt à visser

Cod.	Medidas-Dimensions	
5803	70x130	2



Ferragens para portas corrediças penduradas  
 Hanging sliding door fittings  
 Ferrures pour portes coulissantes suspendues

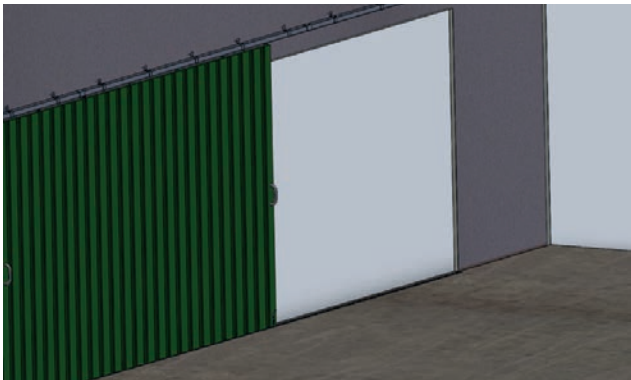
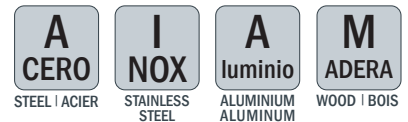

## Puertas correderas colgadas

Portas corrediças penduradas  
 Hanging sliding doors  
 Portes coulissantes suspendues

Hasta	60 kg	U-30
Até	75 kg	U-30
Up to	150 kg	U-40
Jusqu'à	300 kg	U-40
	450 kg	U-60
	1.200 kg	U-70
	2.000 kg	U-70

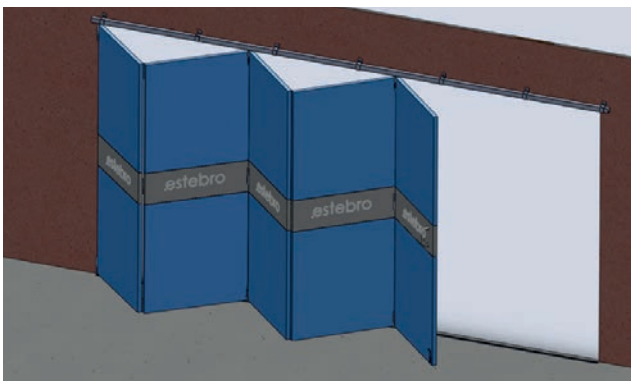

## Puertas correderas plegables solapadas

Portas corrediças drobráveis com lapela  
 Folding doors with overlapping panels  
 Portes pliantes superposés

Hasta		
Até	50 kg	U-40
Up to	100 kg	U-60
Jusqu'à		



## Puertas articuladas en curva

Portas articuladas em curva  
 Sliding curved doors  
 Portes coulissantes cintrées

Hasta	75 kg	U-40
Até	150 kg	U-40
Up to	200 kg	U-60
Jusqu'à		

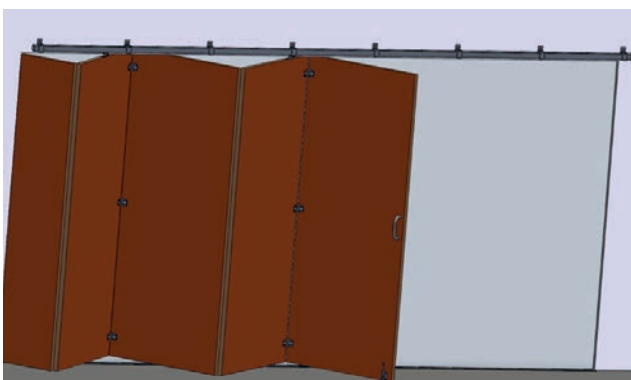

## Puertas correderas de acordeón

Portas de acordeão  
 Accordion doors  
 Portes coulissantes accordéon

Hasta		
Até	50 kg	U-40
Up to	100 kg	U-60
Jusqu'à		



# Herrajes Puertas Correderas Colgadas

Ferragens Portas Correções Penduradas  
Hanging Sliding Door Fittings  
Ferrures pour Portes Coulissantes Suspendues

Gama U-70 | U-70 Line | Gamme U-70

E1200 - E2000



**Raíl superior U-70**  
Trilho superior U-70 | Top rail U-70 |  
Rail supérieur U-70

Cod.	Medidas-Dimensions	
470	U-70	3 m



**Rollapar U-70 simple E1200**  
Rodízio U-70 simple | U-70 Simple trolley |  
Monture à galets simple U-70

Cod.	Medidas-Dimensions	
464L	Simple U-70	2



**Rollapar U-70 doble E2000**  
Rodízio U-70 duplo | U-70 Double trolley |  
Monture à galets double U-70

Cod.	Medidas-Dimensions	
465L	Doble U-70	2



**Rollapar U-70 simple E1200 AXIAL**  
Rodízio U-70 simple axial | U-70 Axial simple trolley |  
Monture à galets simple U-70 axial

Cod.	Medidas-Dimensions	
464Z	Simple U-70 AXIAL	2



**Rollapar U-70 doble E2000 AXIAL**  
Rodízio U-70 duplo axial | U-70 Axial double trolley |  
Monture à galets double U-70

Cod.	Medidas-Dimensions	
465Z	Doble U-70 AXIAL	2



**Tope raíl U-70**  
Topo guía U-70 | Stopper for rails U-70 |  
Butée à visser U-70

Cod.	Medidas-Dimensions	
47201	U-70	4



**Fijación a pared para abrazadera U-70**  
Escuadra parafusar abraçadeira U-70  
Fixation to wall for U-70 support  
Equerre à visser pour support réglable

Cod.	Medidas-Dimensions	
47002	U-70	4



**Abrazadera raíl U-70 ajustable**  
Abraçadeira trilho U-70 ajustável  
U-70 adjustable rail support  
Support réglable rail U-70

Cod.	Medidas-Dimensions	
47001L	U-70	2



**Empalme para raíl U-70**  
Conexão para trilho U-70 | Joint for U-70 rail |  
Manchon de raccordement pour rail U-70

Cod.	Medidas-Dimensions	
470010	U-70	2



**Fijación regulable para abrazaderas U-70**  
Fixação regulável parafusar abraçadeira U-70  
Regulating fixation, to screw, for U-70 supports  
Fixation réglable à visser pour supports U-70

Cod.	Medidas-Dimensions	
47003	U-70	2



**Guiador inferior U-50**  
Guia inferior U-50 | Bottom guide U-50 |  
Guide inférieur U-50

Cod.	Medidas-Dimensions	
5026	U-50	5



**Raíl inferior U-50**  
Trilho inferior U-70 | Bottom rail U-70 |  
Rail inférieur U-70

Cod.	Medidas-Dimensions	
5020	U-50	3 m



**Kit puerta corredera hasta 60 kg**

Até 60 kg | Up to 60 kg | Jusqu'à 60 kg

Cod.	60 kg	1 set
KC60		



**Kit puerta corredera hasta 60 kg -NYLON**

Até 60 kg | Up to 60 kg | Jusqu'à 60 kg

Cod.	60 kg	1 set
KC60N		



**Kit puerta corredera hasta 75 kg**

Até 75 kg | Up to 75 kg | Jusqu'à 75 kg

Cod.	75 kg	1 set
KC75N		



**Raíl superior aluminio U-30 pestaña**

Trilho superior alumínio U-30 pestana

Aluminium top rail U-30 edge

Rail supérieur en aluminium U-30 à rebord

Cod.	Medidas-Dimensions	*1%
5752	U-30 Punzonado	2 m
5751	U-30 Punzonado	3 m



**Escuadra soporte raíl alu. U-30 pestaña**

Esquadro trilho alumínio U-30 pestana

Aluminium bracket for top rail U-30 edge

Équerre pour rail en aluminium U-30 à rebord

Cod.	Medidas-Dimensions
57520	U-30



**Tapa embellecedor raíl aluU-30 pestaña**

Tampa embellecedora trilho alu. U-30 pestana

Alum. escutcheon cap for top rail U-30 edge

Cache embellissant rail alum U-30 à rebord

Cod.	Medidas-Dimensions	
575152	U-30	2 m
575151	U-30	3 m



**Juego embellecedor para tapa embellecedor**

Jogo decorativo tapa em alumínio

End cap kit for escutcheon cap

Jeu d'embouts pour cache en aluminium

Cod.	Dcha + Izq	1 set
57515T		



**Raíl superior aluminio U-30 simple**

Trilho superior alumínio U-30 simple

Aluminium top rail U-30 simple

Rail supérieur en aluminium U-30 simple

Cod.	Medidas-Dimensions	*1%
5592	U-30 Punzonado	2 m
5591	U-30 Punzonado	3 m



**Curva superior aluminio U-30 simple**

Curva alumínio superior simple | Aluminium Top bend simple | Courbe supérieure aluminium simple

Cod.	Medidas-Dimensions	
55913	U-30	1



**Escuadra para soporte raíl aluminio U-30 simple**

Esquadro trilho alumínio U-30 simple

Aluminium bracket for top rail U-30 simple

Équerre pour rail en aluminium U-30 simple

Cod.	Medidas-Dimensions
57525	U-30

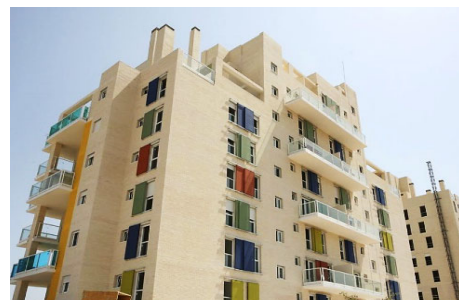



## Herrajes Puertas Correderas Colgadas

Ferragens Portas Corrediças Penduradas  
Hanging Sliding Door Fittings  
Ferrures pour Portes Coulissantes Suspendues

Gama U-30 | U-30 Line | Gamme U-30

E60 - E75



### Raíl superior U-30

Trilho superior | Top rail | Rail supérieur

Cod.	Medidas-Dimensions	$\pm 1\%$
473	U-30 Punzonado	3 m
4732	U-30 Punzonado	2 m
INOX - Stainless steel		AISI 316
4760	U-30 INOX AISI 316	3 m

\* Consultar raíl U-30 sin punzonar



### Curva superior U-30

Curva superior | Top bend | Courbe supérieure

Cod.	Medidas-Dimensions	
4735	U-30	1
INOX - Stainless steel		AISI 316
47351	U-30 INOX	1



### Topo raíl U-30

Topo guía | Stopper for rails | Butée à visser

Cod.	Para-For-Pour	
47301	U-30	10
INOX - Stainless steel		AISI 316
47312	U-30 INOX	10



### Rollapar doble U-30 acero E60

Rodízio U-30 duplo aço | Double trolley U-30 steel |  
Monture à galets double U-30 acier

Cod.	Medidas-Dimensions	
459	U-30 Acero Aço-Steel-Acier	12



### Rollapar doble U-30 nylon E60

Rodízio U-30 duplo nylon | Double trolley U-30 nylon |  
Monture à galets double U-30 nylon

Cod.	Medidas-Dimensions	
459N	U-30 Nylon	12



### Rollapar doble desmontable U-30 nylon E75

Rodízio U-30 duplo nylon | Double trolley U-30 nylon |  
Monture à galets double U-30 nylon

Cod.	Medidas-Dimensions	
4640	U-30 Nylon	12
INOX - Stainless steel		AISI 316
4641	U-30 INOX	12



### Rollapar simple U-30 gancho

Rodízio com gancho | Hook trolley | Monture à crochet

Cod.	Para-For-Pour	
4635	U-30	60



### Set adaptador a madera para rollapar

Set de adaptação a madeira | Adaptor set to wood |  
Set adaptateur à bois

Cod.	Para-For-Pour	
4590	U-30	25



### Abrazadera para raíl U-30

Supporte rail | Rail support | Support rail

Cod.	Para-For-Pour	
4591	U-30	8



### Empalme para raíl U-30

Conexão para trilho | Joint for rail |  
Manchon de raccordement pour rail

Cod.	Para-For-Pour	
47310	U-30	4
INOX - Stainless steel		AISI 316
47311	U-30 INOX	4



### Guiador a suelo de plástico

Guia solo plastico | Plastic floor guide |  
Guide à sol en plastique

Cod.	Medidas-Dimensions	
5006	46,5x15	10



### Curva inferior U-19 para U-30

Curva inferior | Bottom bend | Courbe inférieure

Cod.	Para-For-Pour	
4812	U-19 para Raíl U-30	1
INOX - Stainless steel		AISI 316
48120	U-19 para Raíl U-30 INOX	1

## Herrajes Puertas Correderas Colgadas

Ferragens Portas Correções Penduradas  
Hanging Sliding Door Fittings  
Ferrures pour Portes Coulissantes Suspendues

Gama U-40 | U-40 Line | Gamme U-40

E150 - E300



### Kit puerta corredera hasta 150 kg

Até 150 kg | Up to 150 kg | Jusqu'à 150 kg

Cod.	Medidas-Dimensions	Quantidad
KC150	150 kg	1 set



### Kit puerta corredera hasta 300 kg

Até 300 kg | Up to 300 kg | Jusqu'à 300 kg

Cod.	Medidas-Dimensions	Quantidad
KC300	300 kg	1 set



### Raíl superior U-40

Trilho superior | Top rail | Rail supérieur

Cod.	Medidas-Dimensions	Quantidad
478	U-40	3 m
INOX - Stainless steel		AISI 316
472	U-40 INOX AISI 316	3 m



### Curva superior U-40

Curva superior | Top bend | Courbe supérieure

Cod.	Medidas-Dimensions	Quantidad
477	U-40	1
INOX - Stainless steel		AISI 316
4771	U-40 INOX	1



### Tope raíl U-40

Topo guía | Stopper for rails | Butée à visser

Cod.	Para-For-Pour	Quantidad
47801	U-40	10
INOX - Stainless steel		AISI 316
47812	U-40 INOX	10



### Rollapar simple U-40 E150

Rodízio simple U-40 | Simple trolley U-40 |

Monture à galets simple U-40

Cod.	Medidas-Dimensions	Quantidad
461	U-40 Rueda Acero 167 mm	10
460	U-40 Rueda Nylon 167 mm	10
INOX - Stainless steel		AISI 316
468	U-40 167 mm INOX	10
4683	U-40 167 mm INOX Rueda Nylon	10



### Rollapar colgadero simple U-40

Rodízio pendurado simple | Simple trolley U-40 |

Monture simple U-40 fixation sur plat

Cod.	Medidas-Dimensions	Quantidad
4604	U-40 Acero Aço-Steel-Acier	6
4603	U-40 Nylon	6



### Rollapar doble U-40 E300

Rodízio duplo U-40 | Double trolley U-40 |

Monture à galets double U-40

Cod.	Medidas-Dimensions	Quantidad
466	U-40 Rueda Acero 167 mm	8
463	U-40 Rueda Nylon 167 mm	8
INOX - Stainless steel		AISI 316
469	U-40 167 mm INOX	8
4693	U-40 167 mm INOX Rueda Nylon	8



### Rollapar colgadero doble U-40

Rodízio pendurado duplo | Double trolley U-40 |

Monture double U-40 fixation sur plat

Cod.	Medidas-Dimensions	Quantidad
4634	U-40 Acero Aço-Steel-Acier	8
4632	U-40 Nylon	8



### Rollapar U-40 nylon corto

Rodízio U-40 nylon curto | Trolley U-40 nylon short |

Monture à galets U-40 nylon courte

Cod.	Medidas-Dimensions	Quantidad
4612	Simple U-40 137 mm	10
4662	Doble U-40 137 mm	8



### Rollapar simple U-40 soldar extremo

Rodízio simple U-40 soldar extremo

End simple trolley U-40 to weld

Monture à galets simple d'extrémité à souder U-40

Cod.	Medidas-Dimensions	Quantidad
4615E	Simple U-40	6
INOX - Stainless steel		AISI 316
4685E	Simple U-40 INOX	6



### Rollapar simple U-40 soldar central

Rodízio simple U-40 soldar central

Middle simple trolley U-40 to weld

Monture à galets simple intermédiaire à souder U-40

Cod.	Medidas-Dimensions	Quantidad
4615	Simple U-40	6
INOX - Stainless steel		AISI 316
4685	Simple U-40 INOX	6



## Herrajes Puertas Correderas Colgadas

Ferragens Portas Corrediças Penduradas  
Hanging Sliding Door Fittings  
Ferrures pour Portes Coulissantes Suspendues

Gama U-40 | U-40 Line | Gamme U-40

E150 - E300



### Rollapar doble U-40 soldar central

Rodízio duplo U-40 soldar central  
Middle double trolley U-40 to weld

Monture à galets double intermédiaire à souder U-40

Cod.	Medidas-Dimensions	
466S	Doble U-40	6
INOX - Stainless steel AISI 316		
469S	Doble U-40 INOX	6



### Rollapar U-40 atornillar extremo nylon

Rodízio U-40 parafusar extremo nylon  
End trolley in nylon U-40 to screw

Monture à galets d'extrémité en nylon à visser U-40

Cod.	Medidas-Dimensions	
461AE	Simple U-40	6



### Rollapar U-40 atornillar central nylon

Rodízio U-40 parafusar central nylon  
Middle trolley in nylon U-40 to screw

Monture à galets intermédiaire nylon à visser U-40

Cod.	Medidas-Dimensions	
461A	Simple U-40	6



### Rollapar U-40 atornillar central nylon

Rodízio U-40 parafusar central nylon  
Middle trolley in nylon U-40 to screw

Monture à galets intermédiaire nylon à visser U-40

Cod.	Medidas-Dimensions	
466A	Doble U-40	6

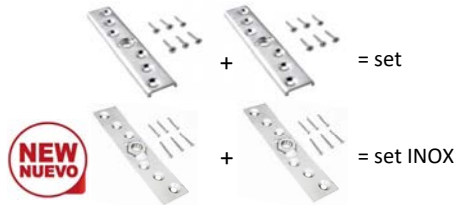

### Set adaptador a madera para rollapar

Set de adaptação a madeira | Adaptor set to wood |  
Set adaptateur à bois

Cod.	Para-For-Pour	
46010	U-40	5 set
INOX - Stainless steel AISI 316		
46011	U-40 INOX	5 set



### Abrazadera soldar para raíl U-40

Abraçadeira soldar | Support to weld |  
Support à souder

Cod.	Para-For-Pour	
4783	U-40	8
INOX - Stainless steel AISI 316		
47830	U-40 INOX	3



### Abrazadera a pared con tornillo U-40

Abraçadeira parede com parafuso |  
Screwed support to wall | Support à mur vissé

Cod.	Para-For-Pour	
4784	U-40	8



### Abrazadera a pared soldada U-40

Abraçadeira parede soldada |  
Welded support to wall | Support à mur soudé

Cod.	Para-For-Pour	
4785	U-40	8
INOX - Stainless steel AISI 316		
47850	U-40 INOX	3



### Abrazadera ajustable para raíl U-40

Abraçadeira ajustável | Adjustable support |  
Support réglable

Cod.	Para-For-Pour	
4786	U-40	8
INOX - Stainless steel AISI 316		
47860	U-40 INOX	3



### Abrazadera a techo para raíl U-40

Abraçadeira para teto | Support to the ceiling |  
Support à plafond

Cod.	Para-For-Pour	
4787	U-40	8
INOX - Stainless steel AISI 316		
47870	U-40 INOX	3



### Empalme para raíl U-40

Conexão para trilho | Joint for rail |  
Manchon de raccordement pour rail

Cod.	Para-For-Pour	
47810	U-40	3
INOX - Stainless steel AISI 316		
47811	U-40 INOX	3



### Curva inferior U-19 para U-40

Curva inferior | Bottom bend | Courbe inférieure

Cod.	Para-For-Pour	
481	U-19 para Raíl U-40	1
INOX - Stainless steel AISI 316		
4810	U-19 para Raíl U-40 INOX	1



### Raíl superior U-60

Trilho superior | Top rail | Rail supérieur

Cod.	Medidas-Dimensions	 ±1%
479	U-60	3 m
INOX - Stainless steel		
485	U-60 INOX AISI 304	3 m
48516	U-60 INOX AISI 316	3 m



### Curva superior U-60

Curva superior | Top bend | Courbe supérieure

Cod.	Medidas-Dimensions	
480	U-60	1
INOX - Stainless steel		
4804	U-60 INOX AISI 304	1
4806	U-60 INOX AISI 316	1



### Tope raíl U-60

Topo guia U-60 | Stopper for rails U-60 |  
Butée à visser U-60

Cod.	Para-For-Pour	
F479	U-60	6



### Rollapar simple U-60 E240

Rodízio simple U-60 | Simple trolley U-60 |  
Monture à galets simple U-60

Cod.	Medidas-Dimensions	
4625	U-60 Acero 180 mm	6
462	U-60 Nylon 180 mm	6
INOX - Stainless steel		AISI 316
483	U-60 180 mm INOX	6



### Rollapar doble U-60 E450

Rodízio duplo U-60 | Double trolley U-60 |  
Monture à galets double U-60

Cod.	Medidas-Dimensions	
4675	U-60 Acero 180 mm	4
467	U-60 Nylon 180 mm	4
INOX - Stainless steel		AISI 316
484	U-60 180 mm INOX	4



### Rollapar U-60 nylon corto E450

Rodízio U-60 nylon curto | Trolley U-60 nylon short |  
Monture à galets U-60 nylon courte

Cod.	Medidas-Dimensions	
4672	Doble U-60 150 mm	4



### Rollapar simple U-60 soldar extremo

Rodízio simple U-60 soldar extremo |  
End simple trolley U-60 to weld | Monture à galets  
simple d'extrémité à souder U-60

Cod.	Medidas-Dimensions	
4625E	Simple U-60	4
INOX - Stainless steel		AISI 316
4835E	Simple U-60 INOX	4



### Rollapar doble U-60 soldar central

Rodízio duplo U-60 soldar central |  
Middle double trolley U-60 to weld | Monture à galets  
double intermédiaire à souder U-60

Cod.	Medidas-Dimensions	
4675S	Doble U-60	4
INOX - Stainless steel		AISI 316
4845	Doble U-60 INOX	4



### Rollapar simple U-60 atornillar extremo

Rodízio simple U-60 parafusar extremo |  
End simple trolley U-60 to screw | Monture à galets  
simple d'extrémité à visser U-60

Cod.	Medidas-Dimensions	
462AE	Simple U-60	6



### Rollapar doble U-60 atornillar central

Rodízio duplo U-60 parafusar central | Middle double  
trolley U-60 to screw | Monture à galets double  
intermédiaire à visser U-60

Cod.	Medidas-Dimensions	
467A	Doble U-60	4

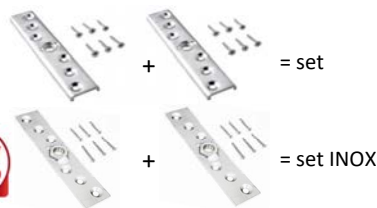

### Set adaptador a madera para rollapar

Set de adaptação a madeira | Adaptor set to wood |  
Set adaptateur à bois

Cod.	Para-For-Pour	
46010	U-40	5 set
INOX - Stainless steel		AISI 316
46011	U-60 INOX	5 set





## Herrajes Puertas Correderas Colgadas

Ferragens Portas Corrediças Penduradas  
Hanging Sliding Door Fittings  
Ferrures pour Portes Coulissantes Suspendues

Gama U-60 | U-60 Line | Gamme U-60

E240 - E450



### Abrazadera soldar para raíl U-60

Abraçadeira soldar | Support to weld | Support à souder

Cod.	Para-For-Pour	
4793	U-60	5
INOX - Stainless steel		AISI 316
47930	U-60 INOX	3



### Abrazadera a pared con tornillo U-60

Abraçadeira parede com parafuso | Screwed support to wall | Support à mur vissé

Cod.	Para-For-Pour	
4794	U-60	5



### Abrazadera a pared soldada U-60

Abraçadeira parede soldada | Welded support to wall | Support à mur soudé

Cod.	Para-For-Pour	
4795	U-60	5
INOX - Stainless steel		AISI 316
47950	U-60 INOX	3



### Abrazadera ajustable para raíl U-60

Abraçadeira ajustável | Adjustable support | Support réglable

Cod.	Para-For-Pour	
4796	U-60	5
INOX - Stainless steel		AISI 316
47960	U-60 INOX	3



### Empalme para raíl U-60

Conexão para trilho | Joint for rail | Manchon de raccordement pour rail

Cod.	Para-For-Pour	
47910	U-60	2
INOX - Stainless steel		AISI 316
47911	U-60 INOX	2



### Curva inferior U-19 para U-60

Curva inferior | Bottom bend | Courbe inférieure

Cod.	Para-For-Pour	
4811	U-19 para Raíl U-60	1
INOX - Stainless steel		AISI 316
48110	U-19 para Raíl U-60 INOX	1

## Accesorios | Acessórios | Accessories | Accessoires



### Perno gota con arandela de latón

Perno gota | Drop profile hinge | Paumelle profil goutte

Cod.	Medidas-Dimensions	
48	20x120	18
INOX - Stainless steel		AISI 316
712	20x120 INOX	10



### Bisagra medio

Dobradiça meio | Middle hinge | Charnière intermédiaire

Cod.		
6955	A tornillar	10



### Guiador inferior U-19

Guia inferior U-19  
Bottom guide U-19  
Guide inférieure U-19

Cod.	Para-For-Pour	
790	U-19	8
INOX - Stainless steel		AISI 316
791	U-19 INOX	8



### Guiador inferior U-19 Nylon

Guia inferior U-19 Nylon  
Bottom guide U-19 Nylon  
Guide inférieure U-19 Nylon

Cod.	Para-For-Pour	
792	U-19 Nylon	8
INOX - Stainless steel		AISI 316
794	U-19 Nylon INOX	8



### Guiador inferior soldar extremo U-19

Guia inferior soldar extremo U-19  
End bottom guide to weld U-19  
Guide inférieure d'extrémité à souder U-19

Cod.	Para-For-Pour	
780E	U-19	6
INOX - Stainless steel		AISI 316
781E	U-19 INOX	6



### Guiador inferior soldar central U-19

Guia inferior soldar central U-19  
Middle bottom guide to weld U-19  
Guide inférieure intermédiaire à souder U-19

Cod.	Para-For-Pour	
780	U-19	10
INOX - Stainless steel		AISI 316
781	U-19 INOX	10



## Herrajes Puertas Correderas Colgadas

Ferragens Portas Corrediças Penduradas  
Hanging Sliding Door Fittings  
Ferrures pour Portes Coulissantes Suspendues

### Accesorios | Acessórios | Accessories | Accessoires



#### Guiador inferior atornillar extremo U-19

Guia inferior parafusar extremo U-19  
End bottom guide to screw U-19  
Guide inférieur d'extrémité à visser U-19

Cod.	Para-For-Pour	
770E	U-19	8



#### Guiador inferior atornillar central U-19

Guia inferior parafusar central U-19  
Middle bottom guide to screw U-19  
Guide inférieur intermédiaire à visser U-19

Cod.	Para-For-Pour	
770	U-19	8



#### Guiador a suelo de plástico

Guia solo plastico  
Plastic floor guide  
Guide à sol en plastique

Cod.	Medidas-Dimensions	
5006	46,5x15	10



#### Guiadores inferiores atornillar U-19

Guías inferiores parafusar U-19  
Bottom guides to screw U-19  
Guides inférieures à visser U-19

Cod.	Para-For-Pour	
25192	U-19	10
25199	U-19 Nylon	10
25195	U-19 Estrecha	20



#### Guía inferior encarcelar simple

Guia inferior encarcelar simple  
Simple guide to fit  
Guide simple à sceller

Cod.		
47110	Simple	2



#### Guía inferior encarcelar doble

Guia inferior encarcelar duplo  
Double guide to fit  
Guide double à sceller

Cod.	Medidas-Dimensions	
47120	32-85 Doble	2



#### Guía inferior atornillar simple

Guia inferior atornillar simple  
Simple guide to screw | Guide simple à visser

Cod.		
47130	Simple	2



#### Guía inferior atornillar doble

Guia inferior atornillar duplo  
Double guide to screw | Guide double à visser

Cod.	Medidas-Dimensions	
47140	18-128 Doble	2



#### Freno

Freio | Brake | Frein

Cod.	Medidas-Dimensions	
5806	120 mm	8



#### Raíl inferior O-19

Trilho inferior | Bottom rail | Rail inférieure

Cod.	Medidas-Dimensions	
471	Omega 19 mm	3 m



#### Raíl inferior U-19

Trilho inferior | Bottom rail | Rail inférieure

Cod.	Medidas-Dimensions	
474	U-19	3 m
INOX - Stainless steel		AISI 316
486	U-19 INOX	3 m



#### Freno radial ajustable

Freio radial ajustável | Adjustable radial brake | Frein radial réglable

Cod.		
470040		1



#### Pistón amortiguador fin de carrera

Pistom amortecedor | Shock absorber piston | Piston amortisseur

Cod.		
470030	95 mm	1



## Herrajes Puertas Correderas Rústicas

Ferragens Portas Corrediças Rústicas  
Rustic Sliding Door Hardware  
Ferrures pour Portes Coulissantes Rustiques

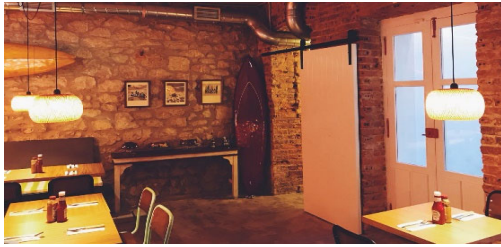

Puerta simple



Puerta doble

### Polea Nylon | Polia Nylon | Nylon wheel | Galet Nylon



**C**  
INCADO  
ZN

\*Incluye tornillería e instrucciones



**N**  
EGRO  
PRETO  
BLACK  
NOIR

\*Incluye tornillería e instrucciones

#### Kits herraje granero - Polea Nylon

Kits porta rustica | Rustic door Kits | Kits porte rustique

Cod.*	Pletina	Polea Nylon		
<b>Ø 60</b>				
KG1830	30x5x1800	60x15	5 unid	1
KG230	30x5x2000	60x15	5 unid	1
KG330	30x5x3000	60x15	8 unid	1
<b>Ø 90</b>				
KG1845	45x8x1800	90x19	5 unid	1
KG245	45x8x2000	90x19	5 unid	1
KG345	45x8x3000	90x19	8 unid	1

#### Kits herraje granero - Polea Nylon

Kits porta rustica | Rustic door Kits | Kits porte rustique

Cod.*	Pletina	Polea Nylon		
<b>Ø 60</b>				
KG1830N	30x5x1800	60x15	5 unid	1
KG230N	30x5x2000	60x15	5 unid	1
KG330N	30x5x3000	60x15	8 unid	1
<b>Ø 90</b>				
KG1845N	45x8x1800	90x19	5 unid	1
KG245N	45x8x2000	90x19	5 unid	1
KG345N	45x8x3000	90x19	8 unid	1

### Polea Acero | Polia Aço | Steel wheel | Galet Acier



**C**  
INCADO  
ZN

\*Incluye tornillería e instrucciones



**N**  
EGRO  
PRETO  
BLACK  
NOIR

\*Incluye tornillería e instrucciones

#### Kits herraje granero - Polea Acero

Kits porta rustica | Rustic door Kits | Kits porte rustique

Cod.*	Pletina	Polea		
<b>Ø 60</b>				
KG1830	30x5x1800	60x15	5 unid	1
KG230	30x5x2000	60x15	5 unid	1
KG330	30x5x3000	60x15	8 unid	1
<b>Ø 90</b>				
KG1845	45x8x1800	90x19	5 unid	1
KG245	45x8x2000	90x19	5 unid	1
KG345	45x8x3000	90x19	8 unid	1

#### Kits herraje granero - Polea Acero

Kits porta rustica | Rustic door Kits | Kits porte rustique

Cod.*	Pletina	Polea		
<b>Ø 60</b>				
KG1830N	30x5x1800	60x15	5 unid	1
KG230N	30x5x2000	60x15	5 unid	1
KG330N	30x5x3000	60x15	8 unid	1
<b>Ø 90</b>				
KG1845N	45x8x1800	90x19	5 unid	1
KG245N	45x8x2000	90x19	5 unid	1
KG345N	45x8x3000	90x19	8 unid	1

## Expositor Kits Rústicas

Expositor Kit Rusticas  
Rustic Kits Exhibitor  
Exposants Kits Rustiques

Mueble + Publicidad  
para Punto de Venta

- ✓ Disponible para:
  - Kits acabado Negro o Cincado
  - Poleas Nylon de 60 x 15
  - Largos de pletina 1,80 m, 2 m y 3 m
- ✓ Incluye tornillería e instrucciones de montaje
- ✓ Incluye publicidad para punto de venta



Más información: [estebro@estebro.es](mailto:estebro@estebro.es)



## Herrajes Puertas Correderas Rústicas

## Ferragens Portas Corrediças Rústicas Rustic Sliding Door Hardware Ferrures pour Portes Coulissantes Rustiques



### Pletina 30x5

Platina | Plate | Platine

Cod.	Medidas-Dimensions	
PL30518	30x5 - CINCADO	1,8 m
PL3052	30x5 - CINCADO	2 m
PL3053	30x5 - CINCADO	3 m
PL30518N	30x5 - NEGRO	1,8 m
PL3052N	30x5 - NEGRO	2 m
PL3053N	30x5 - NEGRO	3 m

\* Precio de pletina completa



### Pletina 45x8

Platina | Plate | Platine

Cod.	Medidas-Dimensions	
PL45818	45x8 - CINCADO	1,8 m
PL4582	45x8 - CINCADO	2 m
PL4583	45x8 - CINCADO	3 m
PL45818N	45x8 - NEGRO	1,8 m
PL4582N	45x8 - NEGRO	2 m
PL4583N	45x8 - NEGRO	3 m

\* Precio de pletina completa



### Pletina 50x10

Platina | Plate | Platine

Cod.	Medidas-Dimensions	
PL501018	50x10 - CINCADO	1,8 m
PL50102	50x10 - CINCADO	2 m
PL50103	50x10 - CINCADO	3 m
PL501018N	50x10 - NEGRO	1,8 m
PL50102N	50x10 - NEGRO	2 m
PL50103N	50x10 - NEGRO	3 m

\* Precio de pletina completa



### Poleas granero Cincado - Rueda Nylon

Polias tipo celeiro | Rustic wheels |

Roues portails agricoles

Cod.	Medidas-Dimensions	
57539	60x15 mm	1
57549	90x19 mm	1
57559	120x22 mm	1



### Poleas granero Negro - Rueda Nylon

Polias tipo celeiro preto | Black rustic wheels |

Roues portails agricoles noir

Cod.	Medidas-Dimensions	
57539N	60x15 mm	1
57549N	90x19 mm	1
57559N	120x22 mm	1



### Poleas granero Cincado - Rueda Acero

Polias tipo celeiro | Rustic wheels |

Roues portails agricoles

Cod.	Medidas-Dimensions	
5753	60x15 mm	1
5754	90x19 mm	1
5755	120x22 mm	1



### Poleas granero Negro - Rueda Acero

Polias tipo celeiro preto | Black rustic wheels |

Roues portails agricoles noir

Cod.	Medidas-Dimensions	
5753N	60x15 mm	1
5754N	90x19 mm	1
5755N	120x22 mm	1



### Poleas granero Doble Negro - Rueda Nylon

Polias tipo celeiro preto | Black rustic wheels |

Roues portails agricoles noir

Cod.	Medidas-Dimensions	
575300N	60x15 mm Delantera	1
575301N	60x15 mm Trasera	1
575400N	90x19 mm Delantera	1
575401N	90x19 mm Trasera	1



### Empalme pletina

Conexão para platina | Plate Joint | Manchon de raccordement pour platine

Cod.	Pletina
E305N	30x5 mm
E458N	45x8 mm
E5010N	50x10 mm



### Tope rústico negro

Topo rustico | Rustic stopper | Butée rustique

Cod.	Medidas-Dimensions
575N	60-90



### Separador pared negro

Separador parede | Wall spacers |

Séparateur de mur

Cod.	Medidas-Dimensions
57533N	Polea 60
57543N	Polea 90
57553N	Polea 120



### Guiador a suelo de plástico

Guia solo plastico | Plastic floor guide |

Guide à sol en plastique

Cod.	Medidas-Dimensions	
5006	46,5x15	10



## Herrajes Puertas Elevables

Ferragens Portas de Elevar  
Overhead Doors Fittings  
Ferrures Portes Basculantes



### Bisagra ángulo superior

Dobrادیça superior | Upper hinge |  
Charnière supérieure

Cod.	Medidas-Dimensions	
163	32x32	18
162	40x40	18



### Bisagra ángulo superior con chapa

Dobrادیça superior | Upper hinge |  
Charnière supérieure

Cod.	Medidas-Dimensions	
164	160x40x8 Iz/Dch	12
160	175x50x10 Iz/Dch	10



### Manilla puertas elevables

Manilha portas elevar | Overhead doors handle |  
Poignée portes basculantes

Cod.	Medidas-Dimensions	
448	Negra Preta Black Noire	15
449	Cromada Chromed Chromée	15



### Polea canal 10 mm

Polia U-10 mm | U-10 mm wheel | Galet U-10 mm

Cod.	Medidas-Dimensions	
100	45x10	30
101	60x10	30
102	70x10	24
103	80x10	15
104	90x10	12
105	100x10	12
106	120x10	7
111	150x10	4
116	180x10	4
112	200x10	4
143	250x10	3



### Polea nylon canal 10 mm

Polia nylon | Nylon wheel | Galet en nylon

Cod.	Medidas-Dimensions	
360	45x10	30
361	60x10	30
362	70x10	24
363	80x10	15
364	90x10	12
365	100x10	12
366	120x10	7
367	150x10	4
381	180x10	4
368	200x10	4



### Polea doble canal

Polia duplo canal | 2 grooves wheel | Galet 2 gorges

Cod.	Medidas-Dimensions	
142	100x29	8
113	120x29	4
114	150x29	4
118	180x29	4
115	200x29	4



### Polea canal cuadrada 10 mm

Polia canal 10 quadrada | 10 squared-groove wheel |  
Galet gorge 10 carrée

Cod.	Medidas-Dimensions	
965	60x10	20
966	70x10	20
967	80x10	15
968	90x10	8
969	100x10	8
970	120x10	6



### Polea canal cuadrada 20 mm

Polia canal 20 quadrada | 20 squared-groove wheel |  
Galet gorge 20 carrée

Cod.	Medidas-Dimensions	
973	80x20	16
974	90x20	8
975	100x20	8
976	120x20	6
977	150x20	4



UPN

### Freno de seguridad / Paracaídas

Freio segurança | Safety brake | Freins de sécurité

Cod.	Medidas-Dimensions	
450	U-40	1 set
452	U-50	1 set
454	U-60	1 set
455	U-80	1 set
4571	U-100	1 set
UPN		
456	UPN 80	1 set
457	UPN 100	1 set



UPN

### Rodillo guía

Rolo guía | Guide roller | Coussinet guide

Cod.	Medidas-Dimensions	
1351	U-40	20
135	U-50	20
136	U-60 M.12	32
141	U-80 M.16	26
137	U-70	20
138	U-80	18
139	U-90	6
140	U-100	6
UPN		
393	UPN 80	18
394	UPN 100	6



Cod.150

Cod.151

### Chapa hexagonal para rodillo guía

Chapa hex. rolo guía | Hex. plate for guide roller |  
Plaque hexagonale pour coussinet guide

Cod.	Medidas-Dimensions	
150	Hexagonal 27	1
151	Hexagonal 32	1



Cod.150  
(Hexagonal 27)

Para For Pour  
Cod.1351  
Cod.135  
Cod.136



Cod.151  
(Hexagonal 32)

Para For Pour  
Cod.141  
Cod.137  
Cod.138  
Cod.139



### Perno inferior con bola

Perno inferior com bola | Bottom pivot with ball |  
Pivot inférieur avec bille

Cod.	Medidas-Dimensions	
563	20 mm	10
564	24 mm	6



### Punto de giro 40 mm a bola

Ponto de rotação a bola 40 mm | Pivot hinge with ball  
40 mm | Pivot 40 mm avec bille

Cod.	Medidas-Dimensions	
165	40 mm Juego Jogo Set Jeu	4
1651	40 mm Superior	10
1652	40 mm Inferior	10

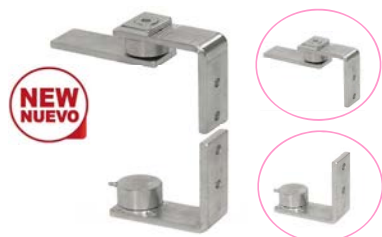

### Punto de giro 50 mm atornillar con rodamiento 50 mm

Ponto de rotação com rolamento 50 mm |  
Pivot hinge to screw 50 mm | Pivot 50 mm à risser

Cod.	Medidas-Dimensions	
293	50 mm Juego Jogo Set Jeu	2
2931	50 mm Superior	4
2932*	50 mm Inferior	4

\* ES: Incluye junta tórica PO: Inclui o-ring EN: Sealing ring included FR: Bague d'étanchéité incluse



### Tope puertas

Tope portas | Gate stopper | Arrêt de portails

Cod.	Medidas-Dimensions	
578	Redondo Round Rond	9
584	Ator. Parafusar Screw Visser	6
585	Encarcelar Embutir Fit Sceller	6



### Bisagra regulable con dado

Dobradiça regulável | Regulating hinge |  
Gond réglable

Cod.	Medidas-Dimensions	
565	M.20	20
569	Placa	18



### Punto de giro 42 mm con rodamiento

Ponto de rotação com rolamento 42 mm |  
Pivot hinge with bearing 42 mm | Pivot 42 mm avec roulement

Cod.	Medidas-Dimensions	
175	42 mm Juego Jogo Set Jeu	3
1751	42 mm Superior	3
1752	42 mm Inferior	6

INOX - Stainless steel	AISI 303-304L	
591	42 mm Juego Jogo Set Jeu	1
5911	42 mm Superior	2
5912	42 mm Inferior	2



### Punto de giro 60 mm con rodamiento

Ponto de rotação com rolamento 60 mm | Pivot hinge  
with bearing 60 mm | Pivot 60 mm avec roulement

Cod.	Medidas-Dimensions	
337	60 mm Juego Jogo Set Jeu	1
3371	60 mm Superior	2
3372	60 mm Inferior	4

INOX - Stainless steel	AISI 303-304L	
590	60 mm Juego Jogo Set Jeu	1
5902	60 mm Superior	2
5903	60 mm Inferior	2



### Maneta regulable

Maneta regulável | Regulating handle |  
Poignée réglable

Cod.	Medidas-Dimensions	
41	25:38 Negra	20
4101	25:38 Cromada	15
36	35:50 Negra	20
38	35:50 Cromada	20
37	45:60 Negra	20
39	45:60 Cromada	15
275	30:70 Negra	20



### Punto de giro cuadrado

Ponto de rotação a quadrado | Squared pivot hinge |  
Pivot carré

Cod.	Medidas-Dimensions	
593	30x40 Juego Jogo Set Jeu	1
594	35x40 Juego Jogo Set Jeu	1
597	40x40 Juego Jogo Set Jeu	1



### Punto de giro 50 mm con rodamiento

Ponto de rotação com rolamento 50 mm |  
Pivot hinge with bearing 50 mm | Pivot 50 mm avec roulement

Cod.	Medidas-Dimensions	
292	50 mm Juego Jogo Set Jeu	2
2921	50 mm Superior	6
2922*	50 mm Inferior	6

\* ES: Incluye junta tórica PO: Inclui o-ring EN: Sealing ring included FR: Bague d'étanchéité incluse



### Punto de giro 70 mm con rodamiento

Ponto de rotação com rolamento 70 mm | Pivot hinge  
with bearing 70mm | Pivot 70 mm avec roulement

Cod.	Medidas-Dimensions	
166	70 mm Juego Jogo Set Jeu	1
1661	70 mm Superior	2
1662 *	70 mm Inferior	4

\* ES: Incluye junta tórica PO: Inclui o-ring EN: Sealing ring included FR: Bague d'étanchéité incluse





## Cerrojos y Pasadores | Acero e INOX

## Ferrolhos e Passadores Bolts and Squared Bolts Verrous et Verrous Carrés



### Cerrojo de atornillar - ACERO

Ferrolho de aparafusar | Bolt to screw |  
Verrou à visser acier

Cod.	Medidas-Dimensions	
<b>Corto - Short - Court</b>		
176 *	70 mm	10
177 *	85 mm	10
178 *	100 mm	10
179 *	120 mm	10
<b>Largo - Longo - Long</b>		
182	200 mm	10
183	250 mm	5
184	300 mm	5
185	400 mm	5
186	500 mm	5
189	600 mm	5

\* ES: Con taladro para cadeado PO: Com furo para cadeado  
EN: With hole for lock FR: Avec trou pour cadenas



### Cerrojo con solapa - ACERO

Ferrolho com solapa | Bolt with flap to weld |  
Verrou avec pattes à souder acier

Cod.	Medidas-Dimensions	
<b>Corto - Short - Court</b>		
156 *	70 mm	15
153 *	85 mm	15
154 *	100 mm	15
155 *	120 mm	12
<b>Largo - Longo - Long</b>		
157	200 mm	15
158	300 mm	10
149	400 mm	10
148	600 mm	10

\* ES: Con taladro para cadeado PO: Com furo para cadeado  
EN: With hole for lock FR: Avec trou pour cadenas



### Cerrojo de soldar - ACERO

Ferrolho soldar | Bolt to weld | Verrou à souder acier

Cod.	Medidas-Dimensions	
<b>Corto - Short - Court</b>		
190 *	85 mm	15
<b>Largo - Longo - Long</b>		
191	200 mm	15
192	400 mm	10
193	600 mm	10

\* ES: Con taladro para cadeado PO: Com furo para cadeado  
EN: With hole for lock FR: Avec trou pour cadenas



### Cerrojo con solapa - INOX AISI 316

Ferrolho com solapa | Bolt with flap to weld |  
Verrou avec pattes à souder

Cod.	Medidas-Dimensions	
INOX - Stainless steel AISI 316		
<b>PULIDO   Polido   Polish   Poli</b>		
156P	CORTO - 70 mm	10
153P	CORTO - 85 mm	10
1545P	CORTO - 110 mm	8
157P	LARGO - 200 mm	6
<b>SATINADO   Acetinado   Satin   Satiné</b>		
156S	CORTO - 70 mm	10
153S	CORTO - 85 mm	10
1545S	CORTO - 110 mm	8
157S	LARGO - 200 mm	6



### Cerrojo de atornillar - INOX AISI 316

Ferrolho de aparafusar | Bolt to screw | Verrou à visser

Cod.	Medidas-Dimensions	
INOX - Stainless steel AISI 316		
<b>PULIDO   Polido   Polish   Poli</b>		
176P	CORTO - 70 mm	10
177P	CORTO - 85 mm	10
1785P	CORTO - 110 mm	8
182P	LARGO - 200 mm	6
184P	LARGO - 300 mm	6
185P	LARGO - 400 mm	6
<b>SATINADO   Acetinado   Satin   Satiné</b>		
176S	CORTO - 70 mm	10
177S	CORTO - 85 mm	10
1785S	CORTO - 110 mm	8
182S	LARGO - 200 mm	6
184S	LARGO - 300 mm	6
185S	LARGO - 400 mm	6



### Pasador cuadrado muelle - INOX AISI 304

Passador quadrado com mola |  
Squared barrel bolt | Verrou carré à ressort

Cod.	Medidas-Dimensions	
INOX - Stainless steel AISI 304		
<b>PULIDO   Polido   Polish   Poli</b>		
637I	200 mm PULIDO	10
646I	300 mm PULIDO	10
649I	400 mm PULIDO	10

Todos con condensa + tornillo.

\* Consultar disponibilidad



### Pasador - ACERO

Passador | Flush bolt | Verrou à levier acier

Cod.	Medidas-Dimensions	
194	Básico Basic Basique	10
198	Fuerte Forte Strong Fort	10
199	Doble acción Duplo Double	10
<b>Remate pasador - Rebite - Plug - Vis</b>		
35	Remate M.8	10



### Pasador cuadrado con muelle - ACERO

Passador quadrado com mola |  
Squared barrel bolt | Verrou carré à ressort acier

Cod.	Medidas-Dimensions	
656	800 mm	10

\* Consultar disponibilidad



### Pasador - INOX AISI 304

Passador | Flush bolt | Verrou à levier

Cod.	Medidas-Dimensions	
INOX - Stainless steel AISI 304		
1940P*	Básico Basic Basique	10
1990P*	Doble acción Duplo Double	10

\* ES: Frontal PULIDO PO: Frontal POLIDO EN: POLISHED front FR: Face POLIE

## Varios

## Vários Other Products Produits Divers



### Tensor

Tensor | Tightener | Tendeur

Cod.		
89	Galvanizado	275
870	Lacado Verde Green Vert	100



### Cerradura de persiana

Fechadura persiana | Lock for roller shutter |  
Serrure à volet roulant

Cod.		
323	Galv. Doble Cierre	1



### Garras para aluminio

Garras para aluminio | Hooks | Griffes

Cod.	Medidas-Dimensions	
90	93x18x0,6 Ligera	2000
91	97x20x0,8 Reforzada	1500
92	118x25x0,8 Puerta	1000
921	120x25x1,5 Especial	500



### Tapón

Tampão | Round cover | Bouchon

Cod.	Medidas-Dimensions	
75	33 mm	300
97	40 mm	700
76	42 mm	700
98	45 mm	600
77	48 mm	500
99	50 mm	500
78	60 mm	350
88	80 mm	50
94	90 mm	40



### Tapón redondo de plástico

Tampão redondo plástico | Round plastic cover |  
Bouchon rond plastique

Cod.	Medidas-Dimensions	
2600	Ø20 mm	200
2601	Ø25 mm	200
2607	Ø30 mm	200
2602	Ø35 mm	200
2603	Ø40 mm	200
2609	Ø42 mm	200
2604	Ø45 mm	200
2605	Ø50 mm	200
2606	Ø60 mm	200



### Tapón cuadrado de plástico

Tampão quadrado plástico | Squared plastic cover  
Bouchon carré plastique

Cod.	Medidas-Dimensions	
2590	20x20 mm	100
2591	30x30 mm	100
2592	40x40 mm	50
2593	50x50 mm	30
2596	60x60 mm	20
2594	80x80 mm	15
2595	100x100 mm	10



### Tapón rectangular de plástico

Tampão quadrado plástico | Squared plastic cover  
Bouchon carré plastique

Cod.	Medidas-Dimensions	
2597	40x30 mm	200
25900	50x20 mm	100
2599	60x30 mm	100
2608	60x40 mm	100
2598	80x40 mm	100
2610	100x50 mm	50
2611	120x60 mm	50



### Tirador de persiana

Puxador persiana | Puller | Poignée store

Cod.		
180	Cincado	200



### Escuadra corta cincada

Esquadro curto | Short square | Equerre courte

Cod.	Medidas-Dimensions	
93	6x20	600

## Fabricación a medida

## Fabricação especial e sob medida Tailor-made production Fabrication spéciale et sur mesure



### Fabricación especial y a medida

### Fabricación especial y a medida

¿Nuevo proyecto en marcha?  
¿Tienes dudas sobre qué herrajes o producto deberías colocar o instalar? O por el contrario,  
¿Tienes claro lo que necesitas pero no lo encuentras?

Fabricamos gran variedad de **productos a medida**,  
en distintos materiales y acabados,

### Te apoyamos

Nuestros ingenieros están a tu disposición.  
Queremos que tu proyecto salga adelante con las mayores garantías de calidad.

Fabricantes desde 1962.





## Manillas y Tiradores Inox

## Manilhas e Puxadores Aço Inox Stainless Steel Handles Béquilles et Poignées Inox



### Manilla modelo 1 ovalado

Manilha redondo | Lever handle round rosette |  
Béquille rosace ronde

Cod.		
TODO INOX - Todo em inox - All in SS - Tout en inox		
9920TOP	AISI 304 PUL	1 set
9920OS	AISI 304 SAT	1 set



### Manilla modelo 2 ovalado

Manilha oval | Lever handle oval rosette |  
Béquille rosace ovale

Cod.		
TODO INOX - Todo em inox - All in SS - Tout en inox		
9921TOP	AISI 304 PUL	1 set
9921TOS	AISI 304 SAT	1 set



9980CS



9980DP  
9980DS



### Bocallave redonda

Escudete de chave redondo |  
Round escutcheon | Rosace clé ronde

Cod.		
9980CS	AISI 304 SAT	1
9980DP	AISI 304 PUL	1
9980DS	AISI 304 SAT	1



### Tirador modelo 5

Puxador | Tubing pull handle | Poignée

Cod.		
9931P04	Set AISI 304 PUL	1 set
9931P16	Set AISI 316 PUL	1 set
9931S04	Set AISI 304 SAT	1 set
9939P04	Simple AISI 304 PUL	1
9939S04	Simple AISI 304 SAT	1



### Tirador modelo 15

Puxador | Tubing pull handle | Poignée

Cod.		
9933P04	Set AISI 304 PUL	1 set
9933S04	Set AISI 304 SAT	1 set
9941P04	Simple AISI 304 PUL	1
9941S04	Simple AISI 304 SAT	1



### Tirador MACIZO modelo 312

Puxador maciço | Solid pull handle | Poignée pleine

Cod.		
TODO INOX - Todo em inox - All in SS - Tout en inox		
9960TP04	AISI 304 PUL	1
9960TS04	AISI 304 SAT	1



### Tirador MACIZO modelo 313

Puxador maciço | Solid pull handle | Poignée pleine

Cod.		
9961P16	AISI 316 PUL	1
9961S04	AISI 304 SAT	1



### Asa tirador

Asa puxador | Tubing pull handle | Poignée

Cod.		
9970S	AISI 304 SAT	1



### Rosetas - Embellecedores

Rosetas-Tampão | Rosettes | Rosaces

Cod.		
9946P	Cromo - PUL	1
9946S	Níquel - SAT	1



### Juego abrazaderas simples 40 mm

Jogo de suportes abraçadeira para tubo 40 mm  
Set of brace supports for 40 mm tube  
Jeu de supports anneaux pour tube 40 mm

Cod.		
99100P03	INOX 303 PUL	1 juego
99100S03	INOX 303 SAT	1 juego
99220P16	INOX 316 PUL	1 juego
99220S16	INOX 316 SAT	1 juego



### Juego abrazaderas dobles 40 mm

Jogo de suportes abraçadeira para tubo 40 mm  
Set of brace supports for 40 mm tube  
Jeu de supports anneaux pour tube 40 mm

Cod.		
99110P03	INOX 303 PUL	1 juego
99110S03	INOX 303 SAT	1 juego
99230P16	INOX 316 PUL	1 juego
99230S16	INOX 316 SAT	1 juego



### Tubo 40 mm

Tubo 40 mm INOX | Stainless steel tube 40 mm |  
Tube 40 mm en INOX

Cod.		
INOX - Stainless steel		AISI 304
T401525P04	INOX 304 PUL	2,25 m
T401525S04	INOX 304 SAT	2,25 m
T401550P04	INOX 304 PUL	2,50 m
T401550S04	INOX 304 SAT	2,50 m
INOX - Stainless steel		AISI 316
T401525P16	INOX 316 PUL	2,25 m
T401525S16	INOX 316 SAT	2,25 m
T401550P16	INOX 316 PUL	2,50 m
T401550S16	INOX 316 SAT	2,50 m

PUL= Pulido | Polido | Polish | Poli  
SAT= Satinado | Acetinado | Satin | Satiné



## Divisorias | Herrajes de Protección

## Ferragens de Protecção Protection Hardware Ferrures de Protection

**NEW  
NUEVO**

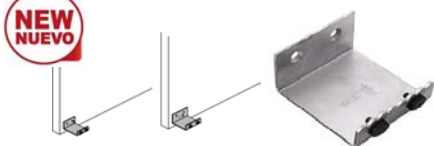

### Tiradores de pie

Puxador de pé | Hand Free foot operated door opener |  
Tire-pieds

Cod.	Medidas-Dimensions	
1803	60x3	10
1804	80x3	10

**NEW  
NUEVO**

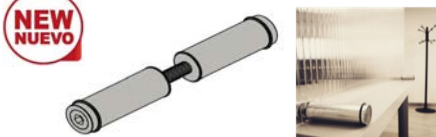

### Patas para divisoria | 25x150 mm

Pés para divisórias | Screen support foot |  
Pattes de fixation de cloisons

Cod.	Medidas-Dimensions	
1720	Acero Zn - 25x150 mm	
INOX - Stainless steel		AISI 316
1721	INOX - 25x150 mm	

**NEW  
NUEVO**

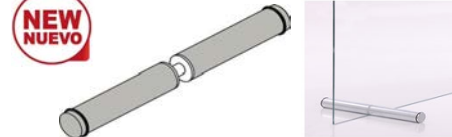

### Patas para divisoria | 35x300 mm

Pés para divisórias | Screen support foot |  
Pattes de fixation de cloisons

Cod.	Medidas-Dimensions	
1730	Acero Zn - 35x300 mm	
INOX - Stainless steel		AISI 316
1731	INOX - 35x300 mm	

**NEW  
NUEVO**



### Soportes para Divisorias

Soportes para divisórias | Screen support clamps |  
Supports de fixation de cloisons

Cod.		
4797	Abrazadera mesa Acero ZN	
INOX - Stainless steel		AISI 316
47970	Abrazadera mesa INOX	

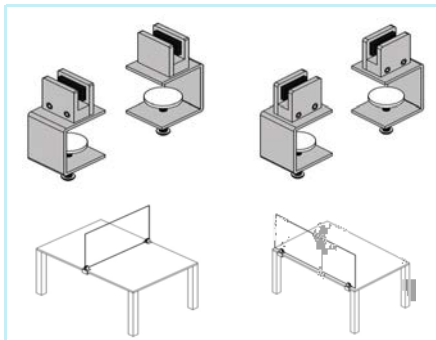

**NEW  
NUEVO**

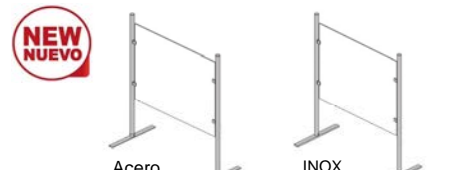

### Postes Divisorias para Mamparas

Postes para divisórias | Screen partition posts |  
Poteaux séparateurs pour cloisons

Cod.	Panel	
ABH0PM15	JUEGO Postes Acero 1,5 m	
ABH0PM2	JUEGO Postes Acero 2 m	
INOX - Stainless steel		AISI 304
AB0PM15S04	JUEGO Postes INOX 1,5 m	
AB0PM2S04	JUEGO Postes INOX 2 m	

Juego=2 postes | El precio incluye 2 postes. Vidrio no incluido

**NEW  
NUEVO**

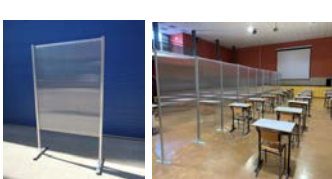

### Mamparas 2.000 mm - Patas

#### Policarbonato celular

Divisorias móveis 2.000 mm - Pernas  
Divider Screen 2.000 mm - Freestanding  
Cloisons amovibles 2.000 mm - Pieds

Cod.	Panel	
<b>Acabado CINCADO</b>		
1805	1.500x1.050 mm - ZN	
1806	1.885x1.050 - ZN	
<b>Acabado PINTADO</b>		
1805P	1.500x1.050 mm - PINTADO	
1806P	1.885x1.050 - PINTADO	

\*Cellular polycarbonate | Polycarbonate cellulaire

**NEW  
NUEVO**



### Mamparas Móviles 2.000 mm - Ruedas

#### Policarbonato celular

Divisorias móveis 2.000 mm - Rodas  
Mobile Divider Screen 2.000 mm - Wheels  
Cloisons amovibles 2.000 mm - Roulettes

Cod.	Panel	
<b>Acabado CINCADO</b>		
1805R	1.500x1.050 mm - ZN	
1806R	1.885x1.050 - ZN	
<b>Acabado PINTADO</b>		
1805RP	1.500x1.050 mm - PINTADO	
1806RP	1.885x1.050 - PINTADO	

\*Cellular polycarbonate | Polycarbonate cellulaire

**NEW  
NUEVO**



### Divisorias Correderas

Divisorias corrediças | Sliding partitions |  
Cloisons coulissantes

Sistemas para divisorias correderas. Consultenos.

**NEW  
NUEVO**

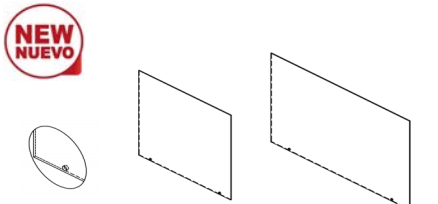

### Cristales Sobremesa y Mostradores

Vidros de balcão e exposição com abertura  
Glass for counters and desks with opening  
Verres pour comptoir et bureau

Cod.	Medidas-Dimensions	
60805	Vidrio placa 600x800x5 mm	
7586	Vidrio placa 750x800x6 mm	
751156	Vidrio placa 750x1150x6 mm	

**NEW  
NUEVO**

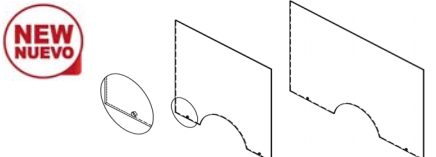

### Cristales Sobremesa y Mostradores

#### Con Apertura

Vidros de balcão e exposição com abertura  
Glass for counters and desks with opening  
Verres pour comptoir et bureau avec ouverte

Cod.	Medidas-Dimensions	
60805T	Vidrio apert. 600x800x5	
7586T	Vidrio apert. 750x800x6	
751156T	Vidrio apert. 750x1150x6	

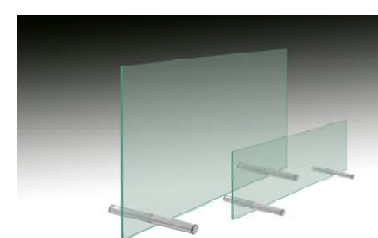

Ejemplo de colocación con Patas

### Cristales y Policarbonatos

También disponibles a medida. Solicite el policarbonato y el cristal/vidrio a la medida que necesite



Cod	Pg	Cod	Pg	Cod	Pg	Cod	Pg
2605	31	7586	33	47911	24	KG1845N	26
2606	31	7586T	33	47930	24	KGN1845	26
2607	31	8012	8	47950	24	KGN1845N	26
2608	31	8111	8	47960	24	PL30518	27
2609	31	8111P	8	47970	33	PL30518N	27
2610	31	8602	16	48110	24	PL3052	27
2611	31	8610C	16	48120	20	PL3052N	27
2921	29	8620C	16	48516	23	PL3053	27
2922	29	8622	16	55913	29	PL3053N	27
2931	29	8630	16	57515T	19	PL45818	27
2932	29	8631	16	57520	19	PL45818N	27
3250	15	9920OS	32	57525	19	PL4582	27
3371	29	9920TOP	32	57533N	27	PL4582N	27
3372	29	9921TOP	32	57539	27	PL4583	27
3562	12	9921TOS	32	57539N	27	PL4583N	27
3563	14	9931P04	32	57543N	27	PL501018	27
3811	13	9931P16	32	57549	27	PL501018N	27
4101	29	9931S04	32	57549N	27	PL50102	27
4240	15	9933P04	32	57553N	27	PL50102N	27
4571	28	9933S04	32	57559	27	PL50103	27
4590	20	9939P04	32	57559N	27	PL50103N	27
4591	20	9939S04	32	60805	33	T401525P04	32
4603	21	9941P04	32	60805T	33	T401525P16	32
4604	21	9941S04	32	68072	10	T401525S04	32
4612	21	9946P	32	68074	10	T401525S16	32
4625	23	9946S	32	68080	10	T401550P04	32
4632	21	9960TP04	32	81110	8	T401550P16	32
4634	21	9960TS04	32	87902	14	T401550S04	32
4635	20	9961P16	32	99100P03	32	T401550S16	32
4640	20	9961S04	32	99100S03	32		
4641	20	9970S	32	99110P03	32		
4642	18	9980CS	32	99110S03	32		
4652	18	9980DP	32	99220P16	32		
4662	21	9980DS	32	992220S16	32		
4672	23	16016	15	99230P16	32		
4675	23	160116/1	15	99230S16	32		
4683	21	160161PI	15	470010	18		
4693	21	16016/2	15	470030	25		
4732	20	16016/2PI	15	470040	25		
4735	20	16016PI	15	470050	12		
4760	20	16730	11	575151	19		
4771	21	17100	12,16	575152	19		
4783	22	25192	25	575300N	27		
4784	22	25195	25	575301N	27		
4785	22	25199	25	575400N	27		
4786	22	25900	31	575401N	27		
4787	22	26016	15	751156	33		
4793	24	26016/1	15	751156T	33		
4794	24	26016/1PI	15	ABH0PM2	33		
4795	24	26016/2	15	ABH0PM15	33		
4796	24	26016/2PI	15	AB0PM12S04	33		
4797	33	26016PI	15	AB0PM15S04	33		
4804	23	36016	15	E305N	27		
4806	23	36016/1	15	E458N	27		
4810	22	36016/1PI	15	E5010N	27		
4811	24	36016/2	15	F479	23		
4812	20	36016/2PI	15	KC150	19		
5006	20,25,27	36016PI	15	KC300	19		
5020	18	46010	22,23	KC60	19		
5026	18	46011	22,23	KC60N	21		
5330	11	47001L	18	KC75N	21		
5391	11	47002	18	KG230	26		
5404	11	47003	18	KG230N	26		
5591	19	47110	25	KGN230	26		
5592	19	47120	25	KGN230N	26		
5751	19	47130	25	KG245	26		
5752	19	47140	25	KG245N	26		
5753	27	47201	18	KGN245	26		
5753N	27	47301	20	KGN245N	26		
5754	27	47310	20	KG330	26		
5754N	27	47311	20	KG330N	26		
5755	27	47312	20	KGN330	26		
5755N	27	47351	20	KGN330N	26		
5792	15,16	47801	21	KG345	26		
5802	15,16	47810	22	KG345N	26		
5803	15,16	47811	22	KGN345	26		
5806	25	47812	21	KGN345N	26		
5902	29	47830	22	KG1830	26		
5903	29	47850	22	KG1830N	26		
5911	29	47860	22	KGN1830	26		
5912	29	47870	22	KGN1830N	26		
6955	24	47910	24	KG1845	26		

[www.estebro.es](http://www.estebro.es)



Estampaciones EBRO, S.L.  
Pol. Ind. Malpica-Alfindén | C/H, 10-12-14-5  
50171 La Puebla de Alfindén, Zaragoza, ESPAÑA



Tel.: (34) 976 107 288  
Fax: (34) 976 108 058



[estebro@estebro.es](mailto:estebro@estebro.es)